

medifab



SPECIAL  
PURPOSE  
STROLLERS

AUSTRALIA

# Introduction to Special Purpose Strollers

Strollers make life as a parent easier – they provide a means to move your child around as you go about everyday activities. When a child has a disability, medical condition, or developmental delay, there may be specific needs or considerations that can be better met through a special purpose stroller, compared to continuing to use a stroller or pram purchased from a department type store.

## Why Might a Special Purpose Stroller Suit My Child?

- Your child's current stroller does not give them enough support to maintain a good sitting position, and you want to be able to access the community with your child.
- Your child fatigues easily, has difficulty walking long distances, or it's more important for your child to conserve their energy for other activities in their day (such as playing with friends or siblings, and going to daycare/school).



**The Pixi and Duro Strollers are designed to manage fatigue in children.**



**The anti-escape buckle can help keep children with developing road safety skills secure.**

- Your child has medical equipment they need to use when in the stroller, and you need to have places on the stroller to attach this to.
- Your child has outgrown stroller options from everyday stores, but still needs support with their mobility in the community.
- Your child is still developing their safety and road awareness skills, so they need a stroller harness that they cannot open themselves to ensure their safety while out in the community.



# Benefits and Features of Special Purpose Strollers:

- Very similar in design to strollers available in retail stores
- Provide additional support for sitting and posture
- Offer both forward and rear-facing seat positions
- In-built growth is available
- Easy to fold
- Seating can be adjusted as required
- Large capacity storage baskets
- Wide variety of accessories available
- Some stroller seats can be removed from the stroller base and attached to an indoor chair base. This means you only need one seat for two different uses



The BINGO Evo Stroller can be altered to face the view or you!



The BINGO Evo Stroller is growth-adjustable.



Robbie uses his BINGO Evo Stroller with his seat adjusted in tilt for more comfort.



The BINGO Evo Stroller has a COBRA Indoor Base, creating a new purpose for the same seat unit.

# How to Choose a Special Purpose Stroller

- **What do you need the stroller for?** The first question to consider is how you'll be using the special purpose stroller. Will it be for flat indoor surfaces or rougher terrain like gravel? Do you plan to walk with your child or also go for runs? Wheel size and direction can be adjusted depending on your needs.
- **Size and weight:** Choose a stroller that fits your child's current size but also allows for growth. Make sure your child stays within the weight limit set by the manufacturer.
- **Support and positioning options:** Some special purpose strollers offer additional postural support through accessories like head, neck, trunk, and foot supports, but not all models provide the same level of support. Some strollers focus on fatigue management or safety, while others are for children needing greater postural support. For example, a child using a stroller for behaviour management may walk independently and require less support than one fully reliant on a stroller for mobility.



**The Duro and Pixi Strollers are tailored to help children with fatigue management and community mobility safety needs.**

- **Accessory attachments:** Consider whether your child has any medical equipment they will need to take with them. Only some special purpose strollers offer additional storage and attachment points for medical equipment, such as oxygen bottles, suction machines, and feeding pumps.



**The BINGO Evo Stroller offers additional storage and attachment points, such as an oxygen bottle holder (left) and IV pole attachment (right).**

- **Transport and lifting:** Make sure you check that you can fold, lift and transport the special purpose stroller as some pack down more compactly than others.

# How to Get the Most Out of Your Trial Appointment

You should always trial the stroller with your child's occupational therapist or physiotherapist present – this is a great opportunity to explore whether the special purpose stroller meets your child's needs and lifestyle requirements.

Some key things to look out for and test in a trial include:

- **How does the stroller fit my child currently?** What is my child's current weight and what is the maximum weight capacity for the stroller?
- **What parts of the special purpose stroller grow?** Some strollers have in-built growth through the seat width, seat depth and backrest height. Some also have conversion kits that allow you to upgrade to the next size stroller of that product by changing a few parts, rather than ordering a whole new stroller. Growth and conversion kits can enable your child to keep using the special purpose stroller for longer.
- **How is my child sitting in the stroller?** Do they need additional support around their hips, trunk, head or feet to maintain a good sitting position?
- **What harness options are there on the special purpose stroller?** What alternative buckle styles are there on this model of stroller to help support my child with behaviours of concern when in the community?
- **Is the stroller easy to transport?** How easy is the stroller to push? How does the stroller fold? Am I able to lift the stroller in and out of my car? How do I remove the seat unit from the stroller base and put it back on?
- **Are family or carers available to attend a trial?** Where possible, having others who support the child try the stroller and share their perspectives can be helpful before deciding on its suitability. Gathering multiple viewpoints can provide the occupational therapist or physiotherapist with valuable information to aid in a funding application.



Scan the QR code to read the Special Purpose Car Seat blog post, or to access our YouTube playlist.



*Disclaimer: This information is provided for professional use only, and as a general resource for clinicians and suppliers. It is not intended to be used as, or as a substitute for, professional medical advice, diagnosis or treatment. Clinicians should rely on their own professional medical training when providing medical advice or treatment, and should consult a range of different information sources before making decisions about the diagnosis or treatment of any person. Your use or reliance on this information is at your own risk.*



SPECIFICATIONS	BINGO MINI	BINGO EVO			BINGO SPEX	
		Size 1	Size 2	Size 3	Size 1	Size 2
DESCRIPTION	A smart stroller base with ultimate early-intervention seating.	A versatile and modular stroller system for users with either basic or critical care needs.			A smart-looking stroller with superior postural support that enables parents to take their child outside and explore.	
APPROX AGE OF USER*	4mths-4yrs	1-5yrs	3-12yrs	8-15yrs	2-5yrs	3-7yrs
MAX LOAD (kg)	25	50			50	
SEAT WIDTH (cm)	13-25	18-30	23-35	23-35	17-28	22-33
SEAT DEPTH (cm)	12-27	16-34	22-40	30-45	18-30	23-38
SHOULDER HEIGHT (cm)	25.5-39.5	28-46	34-55	42-63	36-44	40-48
FOOT SUPPORT HEIGHT RANGE (cm)	16-34	19-40	19-40	19-40	25-40	25-45
FRONT/REAR FACING	Both	Both			Both	
INDOOR FRAME OPTIONS	✓	✓			✓	
APPROX PRODUCT WEIGHT (kg)	17.5	15	16.1	18	29	30
TILT IN SPACE	45°	45°			45°	
RECLINE	80°-180° in 10° steps	90°-160°		90°-135°	90°-160°	
FOOT SUPPORT ELEVATION	✓	✓			✓	
GROWTH ADJUST SEAT	✓	✓			✓	
SWIVEL FRONT WHEELS	✓	✓			✓	
ACTIVITY TRAY	✓	✓			✓	
SUN CANOPY	✓	✓			✓	
RAIN SHIELD	✓	✓			✓	
BASKET STORAGE	✓	✓			✓	
POSTURAL SUPPORT LEVEL	Moderate/Complex	Moderate/Complex			Complex	
TYRE SOLID / PNEUMATIC	Solid	Solid			Solid	
TRANSPORT APPROVED	✓	✓			✓	

\* Indicator only, for accurate product selection client measurements are the best guide.



PIXI		DURO		KOOL STRIDE	MULTIROLLER
Size 1	Size 2	Size 1	Size 2		
Light and nimble stroller with comfortable rigid seating.		Configurable stroller for everyday challenges, with a great range of support and positioning accessories.		Go off road and beyond!	Incredibly light, incredibly tough!
3-7yrs	6-14yrs	3-12yrs	8-15yrs	8-21yrs	8-18yrs
35	50	75		70	75
28	33	23-34	28-39	43	30-38
25 or 30	35 or 40	26-40	31-45	30	33
54 or 60	64 or 70	32-40	42-62	60	29, 38, 48
13-35	13-39	20-44	20-44	45	20 - 30
Front		Front		Front	Front
✗		✗		✗	✗
12.5	15	19.2	21	15	9
✗		Static 16° or 20°		✗	✗
90°-125°		78-120°		✗	✗
✗		✓		✗	✗
5cm growth bracket, seat depth and back height		✓		✗	✓
✓		✓		✗	✓
✓		✓		✗	✗
✓		✓		✓	✓
✓		✓		✓	✗
✓		✓		✓	✗
Moderate		Moderate		Mild	Mild
Combination		Solid		Pneumatic	Pneumatic
✓		✓		✗	✗

Medifab is as diligent as possible in compiling this information. Medifab does not guarantee the correctness and completeness of the information provided. Equally, Medifab does not guarantee that this information is up to date. For questions concerning our products, their specifications and their utilisation please refer to the instruction manual and/or a product consultant of Medifab. Product specifications are subject to change without notice.



# BINGO Evo Mini Stroller

Australia's smallest adaptive stroller with a range of accessories and options to meet the needs of different children.

## Specialised Early Intervention Stroller

### Adjustable seat unit

Seat depth and width, back support height and lower leg length

### Individual upholstery

Removable seat, back, head and laterals cushions allow easy customisation

Multi-directional suspension **protects the child** by absorbing ground bumps, and is effective off road or on rough terrain



**Ergonomic,** height-adjustable push handle

**Sun canopy** option available to allow parents and caregivers to still get out and about, knowing the child is protected from the sun

**Stepless** seat depth adjustment

### BINGO Evo Mini Stroller Package Includes:

- Removable seat
- Tie-downs
- Matte black mobility base
- Hip guides
- Swivel front black mag wheels
- Basket
- Solid tyres
- Adjustable suspension
- Receiver for foot support

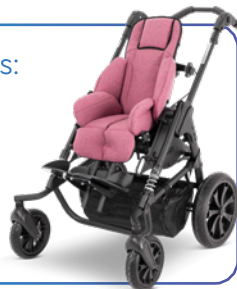

### Colour Options:



Turquoise Soft (-349)



Berry Soft (-347)



Black (-346)

### ONE SEAT. TWO BASE OPTIONS

Indoor COBRA base option available. Height adjustable with the child seated.



### SIZE UPGRADE AVAILABLE



Easily upgrade stroller frame to Size 1 BINGO Evo or BINGO Spex, increasing stroller lifespan.

### TILT

The special construction of the tilt mechanism allows a 45° tilt of the seat unit without compromising the overall stability.



### COMPACT FOLDED SIZE



Easier to store in a car boot! The innovative folding mechanism can be released easily on the push bar.

### BACK SUPPORT RECLINE

The operating elements of the tilt and back support recline are positioned centrally and allow for easy and secure handling.



Size	Code	Seat Load Capacity	Push Handle Height	Overall Width	Seat Depth	Seat Width	Back Support Recline	Shoulder Height	Foot Support Height	Overall Weight	Indoor Base Seat Height	Indoor Base Footprint
0	2880-0008-000	25kg	75-110cm	63cm	12-27cm	13-25cm	80-180°	25.5-39.5cm	16-34cm	17.6kg	27-67.5*	61cm (W) x 71cm (L)

\* Depending on size of castors



# BINGO Evo Mini Accessories

**Occipital Head Support**  
Merino/Spacer Fabric  
2010-4110-099  
**Wipe Down**  
2010-4110-209



**Std Lateral Head Support,**  
Merino/Spacer Fabric  
Small 2010-4210-099  
Large 2010-4211-099



**Standard Lateral Head Support, Wipe Down**  
Small 2010-4210-209  
Large 2010-4211-209



**Ext Lateral Head Support,**  
Merino/Spacer Fabric  
Small 2010-4310-099  
Large 2010-4311-099



**Extended Lateral Head Support, Wipe Down**  
Small 2010-4310-209  
Large 2010-4311-209



**Lateral Head Support Pads**  
0 2880-4470-346



**Seat options:**  
Sacral Support  
2880-2510-060

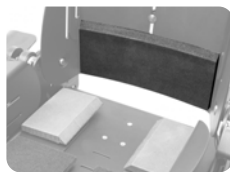

**Seat options:**  
Thigh Wedge  
2006-0505-000

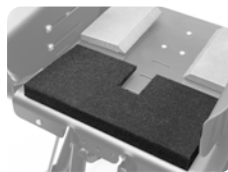

**Seat options:**  
Trochanter Wedges  
2006-0660-000

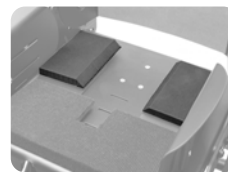

**Upholstery pressure-relief foam upgrades**  
Seat 2880-0391-000  
Back 2880-2392-000



**Std Lateral Support**  
Size 0 2880-3009-346  
Pressure-relief upgrade  
2880-3846-400



**Lateral Trunk Supports**  
Narrow Straight 2880-3007-100  
Broad 2880-3007-310  
Teardrop 2880-3007-500



**Wonderseat Centrepoint Shoulder Harness:**  
0 1409-5660-017



**Wonderseat 4-Point Hip Belt:**  
1406-5420-027



**Spex 5-Point Anterior Chest Support**  
2006-6551-000



**Therapy Tray**  
Can't be used with grab rail  
1 2880-7111-000  
Infill 2880-7180-000



**Grab Rail**  
Can't be used with tray  
2880-7250-346



**Medial Thigh Support**  
2880-1651-346



**Foot Support Spacer**  
2880-5321-000  
**Neoprene Cover**  
2880-5305-000



**Chassis Mount Tray**  
2880-8058-000

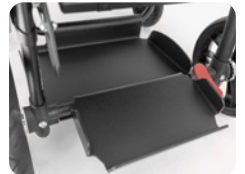

**Ankle Supports**  
2880-6101-000



**IV Pole**  
2880-8275-000  
**Extra Bracket**  
2880-8275-050



**Oxygen Bottle Holder:**  
2880-8253-000



**Hand Strap**  
2005-6930-000



**Swivel Lock:**  
2880-8440-000



**Cobra Indoor Base**  
0 2880-8720-000



**Conversion Kit from Mini to Size 1 (Stroller and Cobra)**  
2880-8080-086



**Separate Seat Unit**  
2881-0010-000



**Twin Bingo Stroller Connection Mount**  
2880-8630-000  
**Attendant Brake**  
2880-8452-000



**Sun Canopy & Rain Shield:**  
With mounts & rain shield  
2880-7501-346



# BINGO Evo Stroller

Larger supportive seating system with many features, including a wide range of accessories and options to meet the needs of different children.

## Modular seating & positioning stroller



Multi-directional suspension **protects the child** by absorbing ground bumps, and is effective off road or on rough terrain

**Easily adjust to rear facing configuration** for improved close interaction with caregiver or monitoring of safety

**Stepless seat depth adjustment**

**Ergonomic, height-adjustable push handle**

**Sun canopy** option available to allow parents and caregivers to still get out and about, knowing the child is protected from the sun

**Adjustable seat depth and width, back support height and lower leg length**

**Note:** Cover shown is an optional extra.

## TUBIE FUN COVERS

Personalise and protect your stroller with waterproof and washable covers from Tubie Fun!



## ONE SEAT. TWO BASE OPTIONS

Indoor Cobra base option available. Height adjustable while the child is seated.



## TILT

The special construction of the tilt mechanism allows a 45° tilt of the seat unit without compromising the overall stability.



## COMPACT FOLDED SIZE



Easier to store in a car boot! The innovative folding mechanism can be released easily on the push bar.

## BACK SUPPORT RECLINE

The operating elements of the tilt and back support recline are positioned centrally and allow for easy and secure handling.



## BINGO Switch:

At the heart of this innovative new design lies an interchangeable front end, a unique feature which eliminates the need to purchase multiple bases. Use the standard wheels for everyday journeys or quickly switch in the third wheel for off-road expeditions, delivering a safe, secure experience across all terrain.

**Size 1:** 2884-0001-500      **Size 2:** 2884-0002-500

### Swivelling Front Wheel Attachment:

**Size 1:** 2884-9571-000      **Size 2:** 2884-9572-000



## BINGO Evo Stroller Package Includes:

- Removable seat
- Hip guides
- Matte black mobility base
- Basket
- Swivel front black mag wheels and solid tyres
- Adjustable suspension
- Tie-downs
- 3 sided foot support



## Colour Options:



**Turquoise Soft**  
(-349)



**Berry Soft**  
(-347)



**Black**  
(-346)

Size	Code	Seat Load Capacity	Overall Length	Overall Width	Seat Depth	Seat Width	Back Support Recline	Shoulder Height	Foot Support Height	Overall Weight	Indoor Base Seat Height	Indoor Base Footprint
1	2881-0008-000	50kg	92cm	63cm	16-34cm	18-30cm	90-160°	28-46cm	16-37cm	15kg	27-67.5*	61cm (W) x 71cm (L)
2	2882-0008-000			68cm	22-40cm	23-35cm	90-160°	34-55cm	16-40cm	16.1kg		
3	2883-0008-000			68cm	27-45cm	23-35cm	90-135°	42-63cm	16-40cm	18kg		

\* Depending on size of castors

# BINGO Evo Accessories

**Occipital Head Support  
Merino/Spacer Fabric  
2010-4110-099  
Wipe Down  
2010-4110-209**



**Std Lateral Head Support,  
Merino/Spacer Fabric  
Small 2010-4210-099  
Large 2010-4211-099**



**Standard Lateral Head  
Support, Wipe Down  
Small 2010-4210-209  
Large 2010-4211-209**



**Ext Lateral Head Support,  
Merino/Spacer Fabric  
Small 2010-4310-099  
Large 2010-4311-099**



**Extended Lateral Head  
Support, Wipe Down  
Small 2010-4310-209  
Large 2010-4311-209**



**Head Support Pads  
1 2880-4471-346  
2 2880-4472-346**



**Head Support Speakers  
2880-8330-000  
(Head support pads required)**



**Std Lateral Trunk Support  
1 2880-3010-346  
2 2880-3020-346  
3 2880-3030-346**



**Spex Lateral Trunk Supports  
Narrow Straight 2880-3008-100  
Broad 2880-3008-310  
Teardrop 2880-3008-500**



**Medial Thigh Support  
1 2880-1651-346  
2 2880-1652-346  
3 2880-1653-346**



**Wonderseat Padded  
Centrepoint Harness  
Size 0 1409-5660-017  
Size 1 1409-6661-017**



**5-Point Anterior  
Chest Support  
Bingo: 2880-6511-346  
Spex: 2006-6551-000**



**Hip Belt  
Spex 2-Point  
1405-6220-027  
Wonderseat 4-Point  
1406-5420-027**



**Groin Strap  
1 2880-6361-346  
2-3 2880-6362-346**



**Anterior Chest Support  
1 2880-6751-346  
2 2880-6752-346  
3 2880-6753-346**



**Ankle Foot Fast  
1 2880-6101-000  
2 2880-6102-000**



**Therapy Tray  
1 2880-7111-000  
2-3 2880-7112-000  
Infill 2880-7180-000**



**Grab Rail  
1 2880-7251-346  
2-3 2880-7252-346**



**IV Pole  
2880-8275-000  
Extra Bracket  
2880-8275-050**



**Oxygen Bottle Holder  
2880-8253-000**



**Chassis Mount Tray  
1 2880-8058-000  
2 2880-8059-000**



**Sacral Support  
2880-2510-060  
Thigh Wedge  
2006-0505-000  
Trochanter Wedges  
2006-0660-000**



**Cobra Indoor Base  
1 2880-8711-000  
2&3 2880-8721-000**



**Separate Seat Unit  
1 2881-0011-000  
2 2882-0012-000  
3 2883-0013-000**



**Twin Bingo Stroller  
Connection Mount  
2880-8630-000  
Attendant Brake  
2880-8452-000**



**Cover Set - Llamas  
Size 1 2880-9561-121  
Size 2 2880-9562-121  
5 Point Harness Cover  
2880-6511-121**

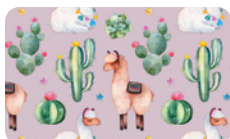

**Cover Set - Planets  
Size 1 2880-9561-036  
Size 2 2880-9562-036  
5 Point Harness Cover  
2880-6511-036**

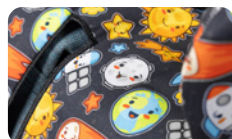

**Foot Support Spacer  
4cm thick  
1 2880-5321-000  
2 2880-5322-000**



**Sun Canopy & Rain Shield:  
2880-7500-346**



**Hand Strap  
2005-6930-000**



**Swivel Lock  
2880-8440-000**





# BINGO Spex Stroller

## A breakthrough in rehabilitative stroller seating.

The BINGO Spex provides a solution for paediatrics that has never been seen before. For children with positioning needs where a stroller is the preferred option for the family, the BINGO Spex provides optimum seating support designed to accommodate even the most challenging postures.



## Create clinical solutions with a Spex cushion and back support system.



### ALLOWANCE FOR HIP/THIGH FLEXION AND PRE-ISCHIAL SUPPORT

A good pelvic foundation is paramount to assist in slowing, or even preventing pelvic and spinal asymmetries. Therefore, the cushion adjusts to correct or accommodate the child's pelvic and thigh needs.



### SPEX POSITIONING CUSHION BASE

Strategic positioning pads can be added or removed from underneath the cushion to allow for different contours and shapes. This way we can meet the client's posture requirements present today and readjust them in the future.



### PELVIC OBLIQUITY BUILD-UP

Pelvic obliquity build-up can be achieved and easily adjusted under the cushion ischial well. Its adjustable pre-ischial area can be adjusted on the spot for greater or lesser anti-thrust needs.



### CREATE INSTANT SHAPE

Back support shaping allows for accommodation or correction of spinal asymmetries, in addition to multi-adjustable lateral trunk supports and anterior chest supports.



### SPEX CONTOURING SYSTEM

A modular and adjustable solution which can be tailored to meet the individual support needs of each child.

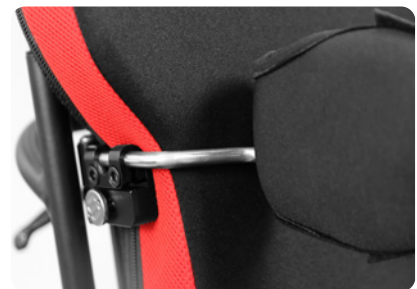

### SUPPORT WHERE IT'S NEEDED

Axial lateral support technology offers unparalleled adjustment to provide trunk support exactly where it's needed, promoting comfort and function.

A smart-looking stroller that enables parents to take their child outside and explore!



Forward to rear-facing seat configuration in 30 seconds!



Adjustable recline, seat tilt and elevating foot support.



**LATERAL HEAD SUPPORT**

Ultimate comfort and positioning for the head with inbuilt lateral and occipital support. Two styles available: Standard Lateral and Extended Lateral (shown).

**Standard** 2885-4241-XXX  
**Extended** 2885-4341-XXX

**Superior comfort and style**

With a wide range of coloured seating options to choose from, the BINGO Spex offers a colour to suit any style. Stand out from the crowd with Chilli Red, look pretty in pink with Calypso Pink, or pick another colour from the rainbow.

(Express delivery on colours stocked in our Devonport Warehouse).



WIPE-DOWN -209

BLACK -099

BUMBLEBEE -044

CALYPSO -028

CHILLI -022

GRANITE -090

LEAF -054

MANGO -030

OCEAN -060

ROYAL -077

**OPTIONAL ACCESSORIES:**

- Hip belt positioning
- Anterior chest supports
- Lateral Head Support
- Oxygen bottle holder
- IV pole
- Axial Pelvic Supports
- Ventilator tray for respiratory equipment
- Feet sandals
- Height-adjustable indoor base

**BINGO SWITCH:**

At the heart of this innovative new design lies an interchangeable front end, a unique feature which eliminates the need to purchase multiple bases. Use the standard wheels for everyday journeys or quickly switch in the third wheel for off-road expeditions, delivering a safe, secure experience across all terrain.

**Size 1** 2884-1001-500      **Size 2** 2884-1002-500

**Swivelling Front Wheel Attachment:**

**Size 1** 2884-9571-000      **Size 2** 2884-9572-000



# BINGO Spex Stroller: User Measurements

BINGO Stroller Size	Size 1		Size 2		
Order Code	2885-0031-032		2885-0032-032		
Seating specs	A Hip width	17-28cm (6.5-11")		22-33cm (8.5-13")	
	B Seat depth	18-30cm (7-12")		23-38cm (9-15")	
	C Back height	36-44cm (14-17")		40-48cm (16-19")	
	D Lower leg length	25-40cm (10-16")		25-45cm (10-18")	
	E Trunk lateral width	12-28cm (5-11")		15-30cm (6-12")	
	F Trunk lateral height	15-34cm (6-13.5")		17-40cm (6.5-16")	
	G Arm support height	15-22cm (6-8.5")		15-22cm (6-8.5")	
	H Internal arm support width	20-32cm (8-13")		28-38cm (11-15")	
	I Head support height*	45-65cm (18-25.5")		50-70cm (20-28")	
	J Cushion total width	33cm (13") Size 1.1	33cm (13") Size 1.2	38cm (15") Size 2.1	38cm (15") Size 2.2
	K Cushion total depth	33cm		38cm	
	L Internal cushion width	23cm (9") Size 1.1	28cm (11") Size 1.2	28cm (11") Size 2.1	33cm (13") Size 2.2
	M Centre of thigh contours	15cm (6") Size 1.1	17cm (6.5") Size 1.2	18cm (7") Size 2.1	20cm (8") Size 2.2
	N Thigh contour depth	10cm (4") Size 1.1	12cm (5") Size 1.2	12cm (5") Size 2.1	15cm (6") Size 2.2
	O Cushion side height	14cm (5.5")		14cm (5.5")	
	P Thigh contour height	9cm (3.5")		9cm (3.5")	
Q Abductor contour height	5cm (2")		5cm (2")		
R Back cushion width	33cm (13")		38cm (15")		
S Trunk cushion width	26cm (10")		30cm (12")		
Stroller specs	Frame seat depth capacity	18-30cm (7-12")		20-38cm (8-15")	
	Frame back height capacity	36-46cm (14-18")		41-55cm (16-22")	
	Backrest recline angle	90-160°			
	Height of push bar	75-110cm (29.5-43")			
	Overall frame width	63cm (25")		68cm (27")	
	Max load of seat unit	50kg (110lb) (body weight including other load)			
	Base frame capacity	60kg (132lb)			

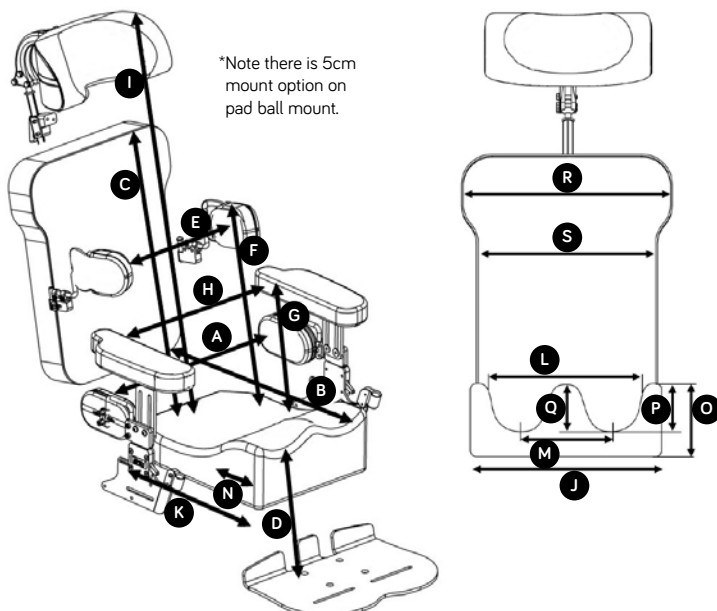

**Stroller Packages Include:** Matte black frame, tie downs, 3kg fabric basket, tray table, and sun canopy.





# Adjustable Seating and Stroller



COBRA height-adjustable indoor base. The seat easily transfers into the COBRA for feeding and other activities. Tilt setting can still be adjusted.  
**Size 1:** 2880-8711-000  
**Size 2:** 2880-8721-000



Seat in forward-facing direction.



Seat in rear-facing direction.

## Unparalleled postural support with innovative Spex seating



### AXIAL PELVIC SUPPORTS

Multi-adjustable pelvic supports can be adjusted in width, angle and depth for optimum pelvic control. These pads are mounted to the quick-release hardware meaning transfers are easy.

**Size 1** 2885-1111-000  
**Size 2** 2885-1112-000



### SPEX BACK SUPPORT

Comfortable pressure-reducing back support with contouring cell system to permit a personal contour for bony prominences, scoliosis and other asymmetrical trunk postures.

**Size 1** 2885-2012-0XX  
**Size 2** 2885-2014-0XX



### SPEX SUPERHIGH CUSHION

Specially designed for a young child who has moderate to high positioning requirements. Spex SuperHigh offers optimal medial and lateral thigh contours to effectively position the pelvis and legs. Spex positioning technology allows further adjustment for pelvic obliquity, hip flexion and other clinical requirements.

**1.1** 2885-0610-0XX    **1.2** 2885-0611-0XX  
**2.1** 2885-0612-0XX    **2.2** 2885-0613-0XX

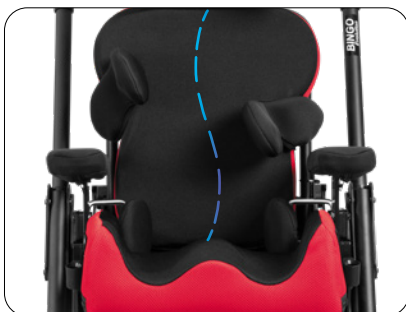

### AXIAL LATERAL TRUNK SUPPORTS

Comfortable lateral trunk supports that are width, depth and multiple angle adjustable. Patented mechanically rotational system allows the lateral pad to rotate to correctly align to the user's trunk. Swing-away hardware makes it easy for carers to transfer the child in and out.

**Narrow** 2885-3410-291  
**Broad** 2885-3431-291



### FOREARM SUPPORTS

Comfortable, padded forearm supports on quick-release hardware make transfers easy for carers.

**Size 1** 2885-5621-291  
**Size 2** 2885-5622-291



### FEET POSITIONING SANDALS

Foot supports provide additional stability for lower limbs and feet, adjustable independently to achieve the optimum foot position.

**Sandals** 2885-6081-000  
**Sandal Raising Blocks** 2885-6091-000

# Pixi Stroller

An attractive, lightweight stroller with rigid seating shell construction.

## Outstanding stability & quick, easy folding



**Easy kerb navigation**  
Handle bar which extends over rear axle

**Back support recline**  
allows the child to sleep or relax

**Easy rear wheel brake system**

**Robust, sturdy design**  
for excellent reliability

**Manoeuvrable -**  
Great stroller to push, with ball bearing castors to easily navigate shopping malls and more

**Pixi Stroller Package Includes:**

- Foldable Frame
- Grey Upholstery (wipe-clean seat surfaces)
- Flip-up Foot Plate
- 5 Point Harness

**Configure for behaviours of concern**

- Anti-escape hip belt 1405-6211-026
- Pen-release hip belt 1405-6211-025
- Anti-escape tee-pad anterior chest support configuration 2560-6556-026



Parents feel great with this smart design.

Quickly folds down to a compact size to place in a vehicle boot. Easy 'lift-to-fold' catches.

Size	Code	Approx Age Of Child	Approx Weight Of Child	Seat Depth	Seat Width	Shoulder Height	Foot Support Height	Approx Stroller Weight
1	2563-0006-191	3-7yrs	35kg	25 or 30cm	28cm	36-45cm	18-30cm	12.5kg
2	2566-0006-191	6-14yrs	50kg	35 or 40cm	32cm	45-55cm	18-35cm	15kg

## ACCESSORIES

**Basket**  
1 2560-8011-017  
2 2560-8012-017



**Chest Strap complete with lateral pads**  
1 2560-6801-090  
2 2560-6802-090



**Standard Lateral Head Support**  
Sml 2010-4210-XXX  
Lrg 2010-4211-XXX



**Extended Lateral Head Support**  
Sml 2010-4310-XXX  
Lrg 2010-4311-XXX



**Occipital Head Support**  
2010-4110-XXX



**Head Support Fabric Options:**

● **Merino/Spacer**  
-099

● **Wipe Down**  
-209

**Tray Table**  
1 2560-7120-013  
2 2560-7130-013



**Medial Thigh Support**  
2560-1501-090



**Rain Shield Cover**  
2560-7601-010



**UV Shade Cover**  
2560-7701-010



**Sun Canopy**  
1 2560-7543-090  
2 2560-7544-090



**Grab Rail**  
1 2560-7253-299  
2 2560-7254-299



**Tie-Downs**  
2560-8501-021



# Duro Stroller

Whether navigating city footpaths or the outdoors terrain, Duro is a stable stroller solution with a great range of support and positioning accessories that will enable you to embrace the outdoors.

Adjustable and durable stroller for everyday adventures



**Extremely agile,** great manoeuvring due to compact mobility base

**Two options for seat angle**

**Adjustable back and knee angle**

**Generous growth capacity** provides long-term use for growing users

**Individually customisable** with accessories from the BINGO Evo Stroller

**Very stable** stroller option



Super compact folding makes the Duro easy to transport and stow in the boot of your car!



Reclining back support means you can relax back in the Duro when being out and about gets tiring!

## Duro Stroller Package Includes:

- Swivelling Front Wheels
  - Foot Support Bracket, Angle Adjustable, Flip Up
  - Foot Support With Heel Stop
  - Accessories Bag (Max Weight: 3kg)
  - Tie Down Kit
  - Retainer for Accessories
  - Hip Guides (Low Version)
- Note: upholstery not included in package



## ACCESSORIES

**Head Support Pads**  
1 2880-4471-346  
2 2880-4472-346



**Grab Rail**  
1 2880-7251-346  
2 2880-7252-346



**Standard Lateral Head Support**  
Sml 2010-4210-XXX  
Lrg 2010-4211-XXX



**Extended Lateral Head Support**  
Sml 2010-4310-XXX  
Lrg 2010-4311-XXX



**Occipital Head Support**  
2010-410-XXX



**Head Support Fabric Options:**

- Merino/Spacer -099
- Wipe Down -209

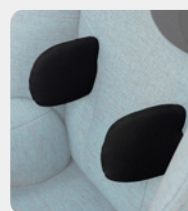

**Std Lateral Trunk Support**  
1 2880-3010-346  
2 2880-3020-346  
3 2880-3030-346  
**Contoured Lateral Trunk Support**  
2006-3030-099  
**Teardrop Lateral Trunk Support**  
1 2006-3110-099  
2 2006-3120-099

**Spex Padded Centrepoint Harness**  
X-Sml 2006-6660-017  
Sml 1409-6661-017  
Med 1409-6662-017



**5-Point Anterior Chest Support**  
2880-6511-000



**Swivel Lock**  
2880-8440-000



**Therapy Tray**  
1 2880-7111-000  
2 2880-7112-000  
Infill 2880-7180-000



Full range of accessories available in the Duro Stroller Scripting and Ordering Guide.

Size	Code	Weight Limit	Seat Width	Seat Depth	Seat Angle	Back Support Height	Back Support Angle	Lower Leg Length	Wheel Diameter	Folded Size (L x W x H)
1	Turquoise: 2780-8801-349	75kg	23cm	26cm	16° or 20°	45cm	78	20cm	20cm front, 30cm rear	84x63 x32cm
	Black: 2780-8801-346		-	40cm		63cm	120°	44cm		
2	Turquoise: 2780-8802-349	75kg	28cm	31cm	16° or 20°	61cm	78	20cm	20cm front, 30cm rear	84x68 x38cm
	Black: 2780-8802-346		39cm	45cm		83cm	120°	44cm		



# Kool Stride Running Stroller

This popular stroller for larger children with disabilities now has a unique advanced feature: an extendable rear wheel system. As the user grows, the rear wheels can extend backwards to maintain stability and control.

Lightweight all-terrain buggy for 10 year olds to young adults



**Dual parking brakes**

**Carrier basket** under seat, and pocket on the back of the seat which can be used to hold drink bottles etc.

**5°-cambered large wheels** make walking **easy** on pathways, gravel or grass

**Lightweight aluminium frame**

**5-point safety anterior chest support**

**Weight limit of 60kg**



**Travelling made easy**

Quick release wheels for easy folding down, simple storage and transport.



Roll the sunhood side flaps up to let the cool air in

Stow the sunhood back

Folds flat and compact for transportation

## EXPLORE ...

Serious sports buggy for cruising outdoors!

- Jogging
- Bushwalks
- Beaches
- Farms

and much more...



## ACCESSORIES

**Rain Cover**  
2650-7600-010

**UV Cover**  
2650-7700-260



Code	Seat Depth	Seat Width	Shoulder Height	Seat Back Height	Foot Support Height	Overall Width	Max Load	Rear Wheel Diameter	Approx Stroller Weight
2650-0001-000	30cm	43cm	50cm	60cm	45cm	68cm	60kg	50cm	15kg

# Multiroller Stroller

Made from quality German-manufactured parts, the Multiroller is a lightweight, high-work-capacity stroller ideal for users with low-level postural support needs who require mobilisation assistance over long distances.

Incredibly light, incredibly tough!

### Build to Last!

Despite its light weight the Multiroller is ultra-durable, with a high work capacity and the ability to hold up to 75kg – perfect for growing users and older occupants.



### Lightweight and Compact

At just 9kg, this sleek and stylish stroller is particularly light, with an easy-fold function making it simple to transport.

### Easy Access

The high seat-to-floor ratio of the Multiroller makes transfers a breeze.

### Interchangeable Front End

Stylish, stable and easy to maneuver, the Multiroller includes an innovative feature which allows the front-end to be changed out for an alternative wheel set – simply swap in the optional jogger wheel set and you've instantly got an off-road solution ready for any terrain!



The high seat-to-floor ratio makes transfers much easier than conventional recreational strollers, while the sling upholstery is both breathable and comfortable. A canopy and drum brakes come as standard.

## ACCESSORIES

**Running Wheel Add On**  
2610-8416-000



**5 Point Harness**  
2610-6500-000



**Seat Depth Extension**  
(Increases seat depth to 38cm)  
2610-0281-000



**Infill for Smaller Users**  
2610-0393-000



**2 Point Hip Belt – Centre Release – Small**  
1405-6211-028



**2 Point Hip Belt – Pen Key Release – Small**  
1405-6211-025



**Anti-Tip**  
2610-8420-000



## Standard Package

- Stroller frame with easy to fold function
- Upholstered seat
- Height adjustable flip up footplate
- Interchangeable front end stroller frame wheelset
- Canopy
- Drum Brakes

### It's Got the Look!

Everything from the sleek black frame to the stylish sling upholstery has been designed to ensure the Multiroller looks as good as it performs.



Code	Overall Width	Seat Depth	Seat Width	Folded size*	Push Handle Height	Shoulder Strap Height	Lower Leg Length	Weight Limit	Approx Stroller Weight
2610-1000-000	68cm	33cm	30 - 38cm	34cm (H) x 56cm (W) x 84cm (L)	86 - 120cm	29cm, 38cm, 48cm	20 - 30cm	75kg	9kg

\*with rear wheels removed



# medifab

Distributed by Medifab Ltd

[solutions@medifab.com](mailto:solutions@medifab.com)

[medifab.com](http://medifab.com)



DISTRIBUTED BY:

Medifab Stroller Flyer\_20241104\_AU