

# medifab

Shaping Better Lives



AUSTRALIA  
CLINICAL EQUIPMENT  
SOLUTIONS

MEDIFAB.COM





Our vision is to  
make a positive  
difference to  
people living  
with disabilities.

# Contents

<b>Strollers</b>	<b>11</b>	<b>Vehicle Harnesses</b>	<b>59</b>
Comparison Chart	12	Medifab Vehicle Harnesses	60
Bingo Evo Mini Stroller	14	Frequently Asked Questions	61
Bingo Evo Stroller	16	Comparison Chart	62
Bingo Spex Stroller	18	Houdini Harnesses	64
Pixi Stroller	22	Walking Rein	66
Duro Stroller	23		
Kool Stride Running Stroller	24	<b>Standing Aids</b>	<b>69</b>
		Comparison Chart	70
<b>Indoor Seating</b>	<b>27</b>	Jenx Monkey Stander	72
Comparison Chart	28	Jenx Multistander	73
Juni Chair	30	Jenx Multistander with Abduction	74
Zoomi+ High Chair	32	Jenx Standz Size 1	75
Gravity Chair	34	Jenx Standz Size 2	76
Cobra Base	35	Jenx Supine Stander	78
Jenx Atom Chair	36		
Jenx Junior+	38	<b>Bathroom</b>	<b>81</b>
		Sharky Bathroom Chair	82
<b>Therapy</b>	<b>41</b>		
Jenx Corner Seat	42	<b>Lying and Positioning</b>	<b>85</b>
Jenx Nursery Table & Therapy Bench	43	Poz'in'form	86
Jenx Ly-On	44	Carewave	90
		Simple Stuff Works	96
<b>Vehicle Seating</b>	<b>47</b>	Dreama	102
Comparison Chart	48		
Carrot 3000 Car Seat	50	<b>Beds</b>	<b>107</b>
Carrot XL Car Seat	52	Safe Surround Genie Bed	108
Hero-NXT Car Seat	54	Safe Surround Plus Bed	109
Starlight-NXT Car Seat	55		
Ipai-LGT Car Seat	56		
Kidsflex Car Seat	57		

## Key



Therapists Normally Choose



Order Me In



Script To Suit

# medifab

## Shaping better lives since 1990.

Grown from small beginnings, the Medifab story is driven by a single-minded purpose – to bring comfort and functionality to people living with disabilities.

We design and manufacture specialist seating and high-quality clinical equipment for children and adults with complex medical needs. Established in 1990 with a genuine passion to help, we innovate to create break-through technologies, so our clients can manage their daily physical and cognitive challenges with the dignity they deserve.

Working closely with therapists, carers and clients, our customer-focussed approach and 'whatever it takes' attitude is at the heart of everything we do. And now, as a leading manufacturer and supplier of high-quality clinical equipment, we continue to push boundaries and adapt our solutions so we can shape better lives in Australia.



medifab

# A culture of going *'the extra smile'*.

We are driven by a single-minded purpose – to bring comfort and functionality to people living with disabilities. Every day, we work towards our mission: **'shaping better lives'**. And our values underpin everything we do.



At Medifab, we specialise in comfort and functionality for those living with disabilities and medical conditions in simpler terms, we 'shape better lives'. You may wonder how we do it. We also specialise in Complex Rehabilitation Technology (CRT) equipment and this enables us to make a positive difference.

We understand that the best way to implement lasting change is to provide individuals with the equipment they need to stay active, comfortable and functional within their homes and communities. With knowledgeable staff and maximising the latest innovations, our breakthrough CRT products play a critical role in helping to tackle daily physical and functional challenges with comfort and ease.

Our world-leading equipment includes strollers, indoor seating, car seats and harnesses, standing and walking aids, beds, sleep systems, and therapy equipment.

## Our company values

---



### LOYALTY

We're committed to our team, our suppliers, partners and every one of our clients, bound by trust, loyalty and respect. Every person and every life matters. Together, we shape better tomorrows for all.



### INTEGRITY

We uphold the strongest moral and ethical principles, every day. We act with responsibility, honesty, sincerity and transparency to create an environment of trust, stability and dependability. Because, when it comes to shaping better lives, integrity is integral.



### VISIONARY THINKING

Innovation sits at the heart of our company, driving us to constantly challenge the status quo. We lead rather than follow, always at the forefront of innovation to re-shape our industry.



### EXCELLENCE

We're committed to shaping a culture of excellence, empowerment and collective contribution, so that we provide exceptional service and products to you, our customers.



### SOLUTIONS

We're a team of creative, 'can-do' problem solvers, dedicated to finding solutions for the most complex medical challenges, and enabling our clients to live better lives.

# Our support network

## Fast delivery of world-leading equipment

We are a trusted stockist for many global brands, and our dedicated team of logistics staff, procurement managers and supply chain specialists facilitated by our quality and regulatory team ensure timely supply to the highest industry standards. This allows us to support Australians living with disabilities with fast supply through our well-established support network of 40+ distributors. We also supply to New Zealand through our home base, warehouses and clinics.



# Our expert knowledge base

We realise that if we want to improve the lives of people living with disabilities and medical conditions, we must share our knowledge with other health professionals. We do just that at conferences, workshops and training events around the world. This is facilitated through the Medifab Professional Development Academy and by partnering with our distributors.



## Joana Santiago, BSc OT

### Head of Clinical Education

Led by our Australian-based Clinical Educator, Joana Santiago, our knowledge base gives carers, medical professionals and therapists the information and tools they need to improve their patients' lives.

An Occupational Therapist with experience working in five different countries, Joana has a comprehensive understanding of postural management and how it can influence everyday functionality and health.



## Jamie Cockle, BSc Physiotherapy

### Paediatric Clinical Educator

Trained Physiotherapist, Jamie Cockle is our Paediatric Clinical Educator and Seating and Positioning Specialist. He provides dedicated training and support for therapists, product specialists and families, helping them to understand the key principles behind Medifab's range of paediatric equipment.

Coming from a background of working in acute hospitals, Jamie gained practical experience with paediatric equipment, developing a talent for understanding people's needs and those of the families supporting them.



## Charlotte Walker, BOT

### Paediatric Product Trainer

Charlotte is an Occupational Therapist with a background in supporting individuals with complex neurological and physical disabilities. From her work as a support worker to teaching occupational therapy students, she's developed unique insights into assistive technology. As a Paediatric Product Trainer, Charlotte's role at Medifab is to support and train distributors and dealers on paediatric products, ensuring successful trials and product usage.

# Encouraging independence and individuality





## Revolutionary wheelchair comfort

A revolution within the clinical equipment industry, our Spex wheelchair seating systems combine clear-cut design advantages with innovative functional features to create a fully adjustable and customisable system that is propelling people's comfort levels to new heights. A dependable and reliable design that maintains any configuration once set, Spex is quickly and easily adjusted on the spot, enabling carers and therapists to provide optimal comfort for users in as short a time frame as possible.

## Spex Catalogue

The Spex logo is displayed in a bold, lowercase, red sans-serif font.

Shaping Better Lives



CLINICAL  
WHEELCHAIR  
SEATING

—  
SPEXSEATING.COM

Do you have this resource?

Email [solutions@medifab.com](mailto:solutions@medifab.com) to request a copy

# Freedom to explore





## Strollers



Have the freedom to explore, with our range of strollers that cater to various needs and sizes. Our focus on clinical and ergonomic support ensures children have the best start in life.

---

BINGO Evo Mini Stroller	14
BINGO Evo Stroller	16
BINGO Spex Stroller	18
Pixi Stroller	22
Duro Stroller	23
Kool Stride Running Stroller	24

---

# Stroller Comparison Chart



SPECIFICATIONS	BINGO MINI	BINGO EVO			BINGO SPEX	
		Size 1	Size 2	Size 3	Size 1	Size 2
DESCRIPTION	Ultimate early intervention seating with smart outdoors stroller.	Versatile and modular stroller system for basic needs, up to critical care users.			A smart - looking stroller with superior postural support, that enables parents to take their child outside and explore!	
APPROX AGE OF USER*	4mths-4yrs	1-5yrs	3-12yrs	8-15yrs	2-5yrs	3-7yrs
MAX LOAD (kg)	25	50			50	
SEAT WIDTH (cm)	13-25	18-30	23-35	23-35	17-28	22-33
SEAT DEPTH (cm)	12-27	16-34	22-40	30-45	18-30	23-38
SHOULDER HEIGHT (cm)	25.5-39.5	28-46	34-55	42-63	36-44	40-48
FOOT SUPPORT HEIGHT RANGE (cm)	16-34	19-40	19-40	19-40	25-40	25-45
FRONT/REAR FACING	Both	Both			Both	
INDOOR FRAME OPTIONS	✓	✓			✓	
APPROX PRODUCT WEIGHT (kg)	17.5	15	16.1	18	29	30
TILT IN SPACE	45°	45°			45°	
RECLINE	80°-180° in 10° steps	90°-160°	90°-135°		90°-160°	
FOOT SUPPORT ELEVATION	✓	✓			✓	
GROWTH ADJUST SEAT	✓	✓			✓	
SWIVEL FRONT WHEELS	✓	✓			✓	
ACTIVITY TRAY	✓	✓			✓	
SUN CANOPY	✓	✓			✓	
RAIN SHIELD	✓	✓			✓	
BASKET STORAGE	✓	✓			✓	
POSTURAL SUPPORT LEVEL	Moderate/Complex	Moderate/Complex			Complex	
TYRE SOLID / PNEUMATIC	Solid	Solid			Solid	
TRANSPORT APPROVED	✓	✓			✓	

\* Indicator only, for accurate product selection client measurements are the best guide.

## STROLLER COMPARISON CHART



Strollers

PIXI		DURO		KOOL STRIDE
Size 1	Size 2	Size 1	Size 2	
Light and nimble stroller with comfortable rigid seating. Child can step on foot support to self-transfer.		Configurable stroller for everyday challenges, with a great range of support and positioning accessories.		Go off road and beyond!
3-7yrs	6-14yrs	3-12yrs	8-15yrs	8-21yrs
35	50	75		70
28	33	23-34	28-39	43
25 or 30	35 or 40	26-40	31-45	30
54 or 60	64 or 70	32-40	42-62	60
13-35	13-39	20-44	20-44	45
Front		Front		Front
✗		✗		✗
12.5	15	19.2	21	15
✗		Static 16° or 20°		✗
90°-125°		78-120°		✗
✗		✓		✗
5cm growth bracket, seat depth and back height		✓		✗
✓		✓		✗
✓		✓		✗
✓		✓		✓
✓		✓		✓
✓		✓		✓
Moderate		Moderate		Mild
Combination		Solid		Pneumatic
✓		✓		✗

Medifab is as diligent as possible in compiling this information. Medifab does not guarantee the correctness and completeness of the information provided. Equally, Medifab does not guarantee that this information is up to date. For questions concerning our products, their specifications and their utilisation please refer to the instruction manual and/or a product consultant of Medifab. Product specifications are subject to change without notice.

# BINGO Evo Mini Stroller

Australia's smallest adaptive stroller with a range of accessories and options to meet the needs of different children.

## Specialised Early Intervention Stroller



**Adjustable seat unit**  
Seat depth and width, back support height and lower leg length

**Easily adjust to rear facing configuration**  
for improved close interaction with caregiver or monitoring of safety

Multi-directional suspension **protects the child** by absorbing ground bumps, and is effective off road or on rough terrain

**Ergonomic,**  
height-adjustable push handle

**Sun canopy**  
option available to allow parents and caregivers to still get out and about, knowing the child is protected from the sun

**Stepless**  
seat depth adjustment

**Mini Package Includes:**

Removable seat, matte black mobility base with swivel front black mag wheels and solid tyres, tie-downs, hip guides, basket, adjustable suspension, receiver for supports & foot support.



### Colour Options:



Turquoise Soft (-349)



Berry Soft (-347)



Black (-346)

### ONE SEAT. TWO BASE OPTIONS

Indoor Cobra base option available.  
Height adjustable with the child seated.



### SIZE UPGRADE AVAILABLE



Easily upgrade stroller frame to Size 1 Bingo Evo or Bingo Spex, increasing stroller lifespan.

### TILT

The special construction of the tilt mechanism allows a 45° tilt of the seat unit without compromising the overall stability.



### COMPACT FOLDED SIZE



Easier to store in a car boot! The innovative folding mechanism can be released easily on the push bar.

### BACK SUPPORT RECLINE

The operating elements of the tilt & back support recline are positioned centrally and allow for easy and secure handling.



Size	Code	Seat Load Capacity	Push Handle Height	Overall Width	Seat Depth	Seat Width	Back Support Recline	Shoulder Height	Foot Support Height	Overall Weight	Indoor Base Seat Height	Indoor Base Footprint
0	2880-0008-000	25kg	75-110cm	63cm	12-27cm	13-25cm	80-180°	25.5-39.5cm	16-34cm	17.6kg	27-67.5*	61cm (W) x 71cm (L)

\* Depending on size of castors

# BINGO Evo Mini Accessories

**Occipital Head Support**  
Merino/Spacer Fabric  
2010-4110-099  
**Wipe Down**  
2010-4110-209



**Std Lateral Head Support,**  
Merino/Spacer Fabric  
Small: 2010-4210-099  
Large: 2010-4211-099



**Standard Lateral Head Support, Wipe Down**  
Small: 2010-4210-209  
Large: 2010-4211-209



**Ext Lateral Head Support,**  
Merino/Spacer Fabric  
Small: 2010-4310-099  
Large: 2010-4311-099



**Extended Lateral Head Support, Wipe Down**  
Small: 2010-4310-209  
Large: 2010-4311-209



**Std Lateral Support**  
Size 0: 2880-3009-346  
Pressure-relief upgrade:  
2880-3846-400



**Seat options**  
Sacral Support:  
2880-2510-060

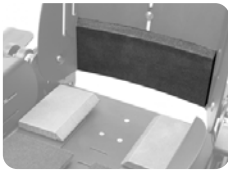

**Lateral Trunk Supports**  
Narrow Straight: 2880-3007-100  
Broad: 2880-3007-310  
Teardrop: 2880-3007-500



**Seat options**  
Thigh Wedge:  
2006-0505-000

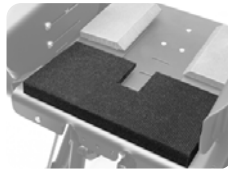

**Wonderseat Centrepoint Shoulder Harness:**  
0: 1409-5660-017



**Seat options**  
Trochanter Wedges:  
2006-0660-000

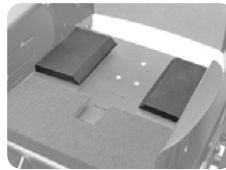

**Wonderseat 4-Point Hip Belt:**  
1406-5420-027



**Spex 5-Point Anterior Chest Support:**  
2006-6551-000



**Hand Strap**  
2005-6930-000



**IV Pole**  
2880-8275-000  
**Extra Bracket**  
2880-8275-050



**Therapy Tray**  
Can't be used with grab rail  
1: 2880-7111-000  
Infill: 2880-7180-000



**Grab Rail**  
Can't be used with tray  
2880-7250-346



**Medial Knee Support**  
1: 2880-1651-346



**Foot Support Spacer**  
2880-5321-000



**Neoprene Foot Support Cover**  
2880-5305-000



**Oxygen Bottle Holder:**  
2880-8253-000



**Chassis Mount Tray**  
2880-8058-000



**Ankle Supports**  
2880-6101-000



**Sun Canopy & Rain Shield:**  
With mounts & rain shield  
2880-7501-346



**Separate Seat Unit**  
2881-0010-000



**Swivel Lock:**  
2880-8440-000



**Cobra Indoor Base**  
0: 2880-8720-000



**Conversion Kit from Mini to Size 1 (Stroller and Cobra)**  
2880-8080-086



**Lateral Head Support Pads**  
0: 2880-4470-346



**Upholstery pressure-relief foam upgrades**  
Seat: 2880-0391-000  
Back: 2880-2392-000



# BINGO Evo Stroller

Larger supportive seating system with many features, including a wide range of accessories and options to meet the needs of different children.

## Modular seating & positioning stroller



Multi-directional suspension **protects the child** by absorbing ground bumps, and is effective off road or on rough terrain

**Easily adjust to rear facing configuration** for improved close interaction with caregiver or monitoring of safety

**Stepless seat depth adjustment**

**Ergonomic, height-adjustable push handle**

**Sun canopy** option available to allow parents and caregivers to still get out and about, knowing the child is protected from the sun

**Adjustable seat unit**  
Seat depth and width, back support height and lower leg length

**Note:** Cover shown is an optional extra.

### PACKAGE INCLUDES:

Removable seat, matte black mobility base with swivel front black mag wheels and solid tyres, tie-downs, hip guides, basket, adjustable suspension and 3 sided foot support.

**Size 1:** 2884-0001-500  
**Size 2:** 2884-0002-500



### BINGO SWITCH:

The innovative and stable quick-release connection offers a quick change from the compact and agile mobility base to the solid all-terrain outdoor version.

**Size 1:** 2884-0001-500  
**Size 2:** 2884-0002-500

### COLOUR OPTIONS:



## NEW TUBIE FUN COVERS

Personalise and protect your Bingo Evo Stroller with our brand-new, waterproof and washable covers from Tubie Fun!



## ONE SEAT. TWO BASE OPTIONS

Indoor Cobra base option available. Height adjustable while the child is seated.



## ADAPTIVE SUSPENSION SYSTEM



Fourfold adjustable frame suspension system which can be easily adjusted without tools.

## TILT

The special construction of the tilt mechanism allows a 45° tilt of the seat unit without compromising the overall stability.



## COMPACT FOLDED SIZE



Easier to store in a car boot! The innovative folding mechanism can be released easily on the push bar.

## BACK SUPPORT RECLINE

The operating elements of the tilt & back support recline are positioned centrally and allow for easy and secure handling.



Size	Code	Seat Load Capacity	Overall Length	Overall Width	Seat Depth	Seat Width	Back Support Recline	Shoulder Height	Foot Support Height	Overall Weight	Indoor Base Seat Height	Indoor Base Footprint
1	2881-0008-000	50kg	92cm	63cm	16-34cm	18-30cm	90-160°	28-46cm	16-37cm	15kg	27-67.5*	61cm (W) x 71cm (L)
2	2882-0008-000			68cm	22-40cm	23-35cm	90-160°	34-55cm	16-40cm	16.1kg		
3	2883-0008-000			68cm	27-45cm	23-35cm	90-135°	42-63cm	16-40cm	18kg		

\* Depending on size of castors



# BINGO Evo Accessories

**Occipital Head Support**  
Merino/Spacer Fabric  
2010-4110-099  
**Wipe Down**  
2010-4110-209



**Std Lateral Head Support,**  
Merino/Spacer Fabric  
Small: 2010-4210-099  
Large: 2010-4211-099



**Standard Lateral Head Support, Wipe Down**  
Small: 2010-4210-209  
Large: 2010-4211-209



**Ext Lateral Head Support,**  
Merino/Spacer Fabric  
Small: 2010-4310-099  
Large: 2010-4311-099



**Extended Lateral Head Support, Wipe Down**  
Small: 2010-4310-209  
Large: 2010-4311-209



**Std Lateral Trunk Support**  
1: 2880-3010-346  
2: 2880-3020-346  
3: 2880-3030-346



**Spex Lateral Trunk Supports**  
Narrow Straight: 2880-3008-100  
Broad: 2880-3008-310  
Teardrop: 2880-3008-500



**Additional Padding**  
Sacral Support: 2020-2510-060  
Thigh Wedge: 2006-0505-000



**Medial Knee Support**  
1: 2880-1651-346  
2: 2880-1652-346  
3: 2880-1653-346



**Anterior Chest Support**  
1: 2880-6751-346  
2: 2880-6752-346  
3: 2880-6753-346



**Wonderseat Padded Centrepoint Harness**  
Size 0: 1409-5660-017  
Size 1: 1409-6661-017



**5-Point Anterior Chest Support**  
Bingo: 2880-6511-346  
Spex: 2006-6551-000



**Hip Belt**  
Spex 2-Point: 1405-6220-027  
Wonderseat 4-Point: 1406-5420-027



**Groin Strap**  
1: 2880-6361-346  
2-3: 2880-6362-346



**Foot Support Spacer 4cm thick**  
1: 2880-5321-000  
2: 2880-5322-000



**Ankle Foot Fast**  
1: 2880-6101-000  
2: 2880-6102-000



**Therapy Tray**  
1: 2880-7111-000  
2-3: 2880-7112-000  
Infill: 2880-7180-000

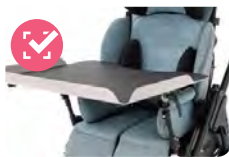

**Grab Rail**  
1: 2880-1651-346  
2-3: 2880-1652-346



**IV Pole:**  
2880-8275-000  
**Extra Bracket**  
2880-8275-050

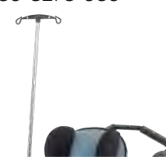

**Oxygen Bottle Holder:**  
2880-8253-000



**Chassis Mount Tray**  
1: 2880-8058-000  
2: 2880-8059-000



**Separate Seat Unit**  
1: 2881-0011-000  
2: 2882-0012-000  
3: 2883-0013-000



**Sun Canopy & Rain Shield:**  
2880-7500-346



**Cobra Indoor Base**  
1: 2880-8711-000  
2: 2880-8721-000



**Head Support Pads**  
1 2880-4471-346  
2 2880-4472-346



**Swivel Lock:**  
2880-8440-000



**Cover Set - Llamas**  
Size 1: 2880-9561-121  
Size 2: 2880-9562-121



**5 Point Harness Cover:**  
2880-6511-121

**Cover Set - Planets**  
Size 1: 2880-9561-036  
Size 2: 2880-9562-036



**5 Point Harness Cover:**  
2880-6511-036

# BINGO Spex Stroller

## A breakthrough in rehabilitative stroller seating.

The BINGO Spex provides a solution for paediatrics that has never been seen before. For children with positioning needs where a stroller is the preferred option for the family, the BINGO Spex provides an optimum seating support designed to accommodate even the most challenging postures.



## Create clinical solutions with a Spex cushion and back support system



### ALLOWANCE FOR HIP/THIGH FLEXION AND PRE-ISCHIAL SUPPORT

A good pelvic foundation is paramount to assist in slowing, or even preventing pelvic and spinal asymmetries. Therefore, the cushion adjusts to correct or accommodate the child's pelvic and thigh needs.



### SPEX POSITIONING CUSHION BASE

Strategic positioning pads can be added or removed from underneath the cushion to allow for different contours and shapes. This way we can meet the client's posture requirements present today; and readjust them in the future.



### PELVIC OBLIQUITY BUILD-UP

Pelvic obliquity build-up can be achieved and easily adjusted under the cushion ischial well. Its adjustable pre-ischial area can be adjusted on-the-spot for greater or lesser anti-thrust needs.



### CREATE INSTANT SHAPE

Back support shaping allows for accommodation or correction of spinal asymmetries, in addition to multi-adjustable lateral trunk supports and anterior chest supports.



### SPEX CONTOURING SYSTEM

A modular and adjustable solution which can be tailored to meet the individual support needs of each child.



### SUPPORT WHERE IT'S NEEDED

Axial lateral support technology offers unparalleled adjustment to provide trunk support exactly where it's needed, promoting comfort and function.

A smart-looking stroller that enables parents to take their child outside and explore!  
(A sun canopy is included in the package).



Forward to rear facing seat configuration in 30 seconds!



Adjustable recline, seat tilt and elevating foot support.



**LATERAL HEAD SUPPORT**

Ultimate comfort and positioning for the head with inbuilt lateral and occipital support. 2 styles available: standard lateral and extended lateral (shown).  
Standard 2885-4241-XXX  
Extended 2885-4341-XXX

**Superior comfort and style**

With a wide range of coloured seating options to choose from, the BINGO Spex offers a colour to suit any style. Stand out from the crowd with Chilli Red, look pretty in pink with Calypso Pink, or pick another colour from the rainbow.

(Express delivery on colours stocked in our Devonport Warehouse).



WIPE-DOWN  
-209

BLACK  
-099

BUMBLEBEE  
-044

CALYPSO  
-028

CHILLI  
-022

GRANITE  
-090

LEAF  
-054

MANGO  
-030

OCEAN  
-060

ROYAL  
-077

**BINGO SPEX TECHNOLOGY**

- Spex cushion
- Spex back support
- Axial lateral trunk supports
- Forearm supports

**FRAME AND SEAT FEATURES**

- BINGO OT mobility base in matte black
- Open footrest platform
- Tray table
- Elevating legrest allowing for contractures 85°-160°
- Sun Canopy and Rain Shield

- Basket
- Transport tie-downs

**OPTIONS**

- Hip belt positioning
- Anterior chest supports
- Lateral Head Support
- Oxygen bottle holder
- IV pole
- Axial Pelvic Supports
- Ventilator tray for respiratory equipment
- Feet sandals
- Height-adjustable indoor base

# BINGO Spex Stroller User measurements

BINGO Stroller Size	Size 1		Size 2		
Order Code	2885-0031-032		2885-0032-032		
Seating specs	A Hip width	17-28cm (6.5-11")		22-33cm (8.5-13")	
	B Seat depth	18-30cm (7-12")		23-38cm (9-15")	
	C Back height	36-44cm (14-17")		40-48cm (16-19")	
	D Lower leg length	25-40cm (10-16")		25-45cm (10-18")	
	E Trunk lateral width	12-28cm (5-11")		15-30cm (6-12")	
	F Trunk lateral height	15-34cm (6-13.5")		17-40cm (6.5-16")	
	G Arm support height	15-22cm (6-8.5")		15-22cm (6-8.5")	
	H Internal arm support width	20-32cm (8-13")		28-38cm (11-15")	
	I Head support height*	45-65cm (18-25.5")		50-70cm (20-28")	
	J Cushion total width	33cm (13") Size 1.1	33cm (13") Size 1.2	38cm (15") Size 2.1	38cm (15") Size 2.2
	K Cushion total depth	33cm		38cm	
	L Internal cushion width	23cm (9") Size 1.1	28cm (11") Size 1.2	28cm (11") Size 2.1	33cm (13") Size 2.2
	M Centre of thigh contours	15cm (6") Size 1.1	17cm (6.5") Size 1.2	18cm (7") Size 2.1	20cm (8") Size 2.2
	N Thigh contour depth	10cm (4") Size 1.1	12cm (5") Size 1.2	12cm (5") Size 2.1	15cm (6") Size 2.2
	O Cushion side height	14cm (5.5")		14cm (5.5")	
	P Thigh contour height	9cm (3.5")		9cm (3.5")	
Q Abductor contour height	5cm (2")		5cm (2")		
R Back cushion width	33cm (13")		38cm (15")		
S Trunk cushion width	26cm (10")		30cm (12")		
Stroller specs	Frame seat depth capacity	18-30cm (7-12")		20-38cm (8-15")	
	Frame back height capacity	36-46cm (14-18")		41-55cm (16-22")	
	Backrest recline angle	90-160°			
	Height of push bar	75-110cm (29.5-43")			
	Overall frame width	63cm (25")		68cm (27")	
	Max load of seat unit	50kg (110lb) (body weight including other load)			
	Base frame capacity	60kg (132lb)			

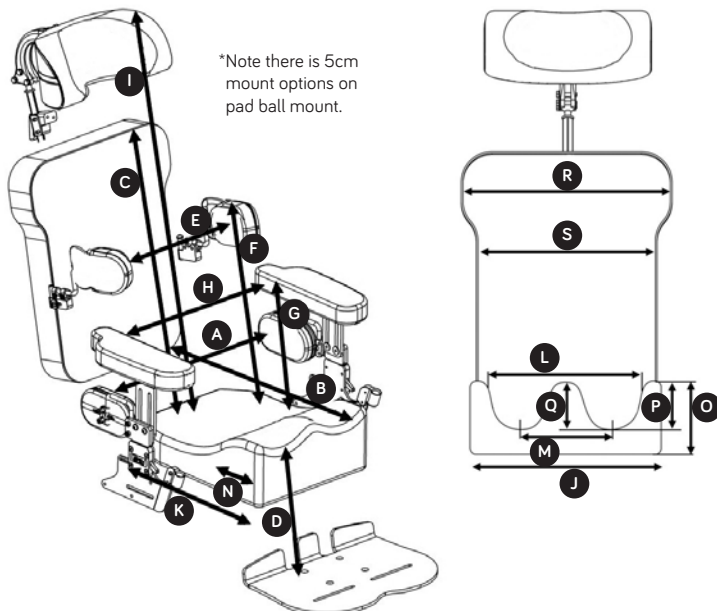

**Stroller Package Includes:** Matte black frame, tie downs, 3kg fabric basket, tray table, and sun canopy.



# Adjustable seating and stroller



Cobra height-adjustable indoor base. The seat easily transfers into the Cobra for feeding and other activities. Tilt setting can still be adjusted.  
**Size 1:** 2880-8711-000  
**Size 2:** 2880-8721-000



Seat in forward facing direction.



Seat in rear facing direction.

## Unparalleled postural support with innovative Spex seating



### AXIAL PELVIC SUPPORTS

Multi-adjustable pelvic supports can be adjusted in width, angle and depth for optimum pelvic control. These pads are mounted to the quick-release hardware meaning transfers are easy.

**Size 1:** 2885-1111-000  
**Size 2:** 2885-1112-000

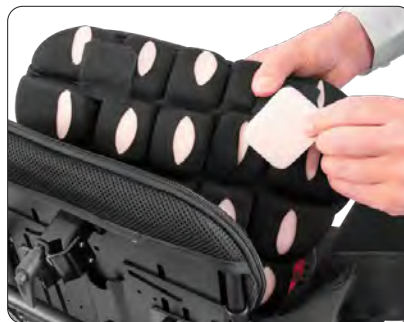

### SPEX BACK SUPPORT

Comfortable pressure-reducing back support with contouring cell system to permit a personal contour for bony prominences, scoliosis and other asymmetrical trunk postures.

**Size 1:** 2885-2012-OXX  
**Size 2:** 2885-2014-OXX



### SPEX SUPERHIGH CUSHION

Specially designed for a young child who has moderate to high positioning requirements. Spex SuperHigh offers optimal medial and lateral thigh contours to effectively position the pelvis and legs. Spex positioning technology allows further adjustment for pelvic obliquity, hip flexion and other clinical requirements.

**1.1:** 2885-0610-OXX    **1.2:** 2885-0611-OXX  
**2.1:** 2885-0612-OXX    **2.2:** 2885-0613-OXX



### AXIAL LATERAL TRUNK SUPPORTS

Comfortable lateral trunk supports that are width, depth and multiple angle adjustable. Patented mechanically rotational system allows the lateral pad to rotate to correctly align to the user's trunk. Swing-away hardware make it easy for carers to transfer the child in and out.

**Narrow:** 2885-3410-291  
**Broad:** 2885-3431-291



### FOREARM SUPPORTS

Comfortable, padded forearm supports on quick-release hardware make transfers easy for the carers.

**Size 1:** 2885-5621-291  
**Size 2:** 2885-5622-291



### FEET POSITIONING SANDALS

Foot supports provide additional stability for lower limbs and feet, adjustable independently to achieve the optimum foot position.

**Sandals:** 2885-6081-000  
**Sandal Raising Blocks:** 2885-6091-000

# Pixi Stroller

An attractive, lightweight stroller with rigid seating shell construction.

## Outstanding stability & quick, easy folding



**Easy kerb navigation**  
Handle bar which extends over rear axle

**Back support recline**  
allows the child to sleep or relax

**Easy rear wheel brake system**

**Robust, sturdy design**  
for excellent reliability

**Manoeuvrable!**  
Great stroller to push, with ball bearing castors to easily navigate shopping malls and more

**Standard Package Includes:**

- Foldable Frame
- Grey Upholstery (wipeclean seat surfaces)
- Flip-up Foot Plate
- 5 Point Harness

**Configure for behaviours of concern**

- Anti-escape hip belt 1405-6211-026
- Pen-release hip belt 1405-6211-025
- Anti-escape tee-pad anterior chest support configuration 2560-6556-026



Parents feel great with this smart design.

Quickly folds down to a compact size to place in a vehicle boot. Easy 'lift-to-fold' catches.

### ACCESSORIES

**Basket**  
1 2560-8011-017  
2 2560-8012-017



**Chest Strap complete with lateral pads**  
1 2560-6801-090  
2 2560-6802-090



**Standard Lateral Head Support**  
Sml 2010-4210-XXX  
Lrg 2010-4211-XXX



**Extended Lateral Head Support**  
Sml 2010-4310-XXX  
Lrg 2010-4311-XXX



**Occipital Head Support**  
2010-4110-XXX



**Head Support Fabric Options:**

- Merino/Spacer -099
- Wipe Down -209

**Tray Table**  
1 2560-7120-013  
2 2560-7130-013



**Medial Knee Support**  
2560-1501-090



**Rain Shield Cover**  
2560-7601-010



**UV Shade Cover**  
2560-7701-010



**Sun Canopy**  
1 2560-7543-090  
2 2560-7544-090



**Grab Rail**  
1 2560-7253-299  
2 2560-7254-299



**Tie-Downs**  
2560-8501-021



Size	Code	Approx Age Of Child	Approx Weight Of Child	Seat Depth	Seat Width	Shoulder Height	Foot Support Height	Approx Stroller Weight
1	2563-0006-191	3 - 7yrs	35kg	25 or 30cm	28cm	36 - 45cm	18 - 30cm	12.5kg
2	2566-0006-191	6 - 14yrs	50kg	35 or 40cm	32cm	45 - 55cm	18 - 35cm	15kg

# Duro Stroller

Whether navigating city footpaths or the outdoors terrain, Duro is a stable stroller solution with a great range of support and positioning accessories that will enable you to embrace the outdoors.

## Adjustable and durable stroller for everyday adventures



**Extremely agile,** great manoeuvring due to compact mobility base

**Two options for seat angle**

**Adjustable back and knee angle**

**Generous growth capacity** provides long-term use for growing users

**Individually customisable** with accessories from the BINGO Evo Stroller

**Very stable** stroller option



Super compact folding makes the Duro easy to transport and stow in the boot of your car!



Reclining back support means you can relax back in the Duro when being out and about gets tiring!

**Package Includes:**

- Swivelling Front Wheels
- Foot Support Bracket, Angle Adjustable, Flip Up
- Foot Support With Heel Stop
- Accessories Bag (Max Weight: 3kg)
- Tie Down Kit
- Retainer for Accessories
- Hip Guides (Low Version)

Note: Upholstery Not Included In Package



## ACCESSORIES

**Head Support Pads**  
1 2880-4471-346  
2 2880-4472-346



**Grab Rail**  
1 2880-7251-346  
2 2880-7252-346

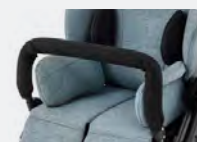

**Standard Lateral Head Support**  
Sml 2010-4210-XXX  
Lrg 2010-4211-XXX



**Extended Lateral Head Support**  
Sml 2010-4310-XXX  
Lrg 2010-4311-XXX



**Occipital Head Support**  
2010-4110-XXX



**Head Support Fabric Options:**

- Merino/Spacer -099
- Wipe Down -209

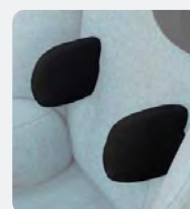

**Std Lateral Trunk Support**  
1 2880-3010-346  
2 2880-3020-346  
3 2880-3030-346

**Contoured Lateral Trunk Support**  
2006-3030-099

**Teardrop Lateral Trunk Support**  
1 2006-3110-099  
2 2006-3120-099

**Spex Padded Centrepoint Harness**  
X-Sml 2006-6660-017  
Sml 1409-6661-017  
Med 1409-6662-017



**5-Point Anterior Chest Support**  
2880-6511-000



**Swivel Lock**  
2880-8440-000



**Therapy Tray**  
1: 2880-7111-000  
2: 2880-7112-000  
Infill: 2880-7180-000



Full range of accessories available in the Duro Stroller Scripting and Ordering Guide.

Size	Code	Weight Limit	Seat Width	Seat Depth	Seat Angle	Back Support Height	Back Support Angle	Lower Leg Length	Wheel Diameter	Folded Size (L x W x H)
1	Turquoise - 2780-8801-349	75kg	23cm	26cm	16° or 20°	45cm	78°	20cm	20cm front, 30cm rear	84x63 x32cm
	Black - 2780-8801-346		-	40cm		63cm		44cm		
2	Turquoise - 2780-8802-349	75kg	28cm	31cm	16° or 20°	61cm	78°	20cm	20cm front, 30cm rear	84x68 x38cm
	Black - 2780-8802-346		39cm	45cm		83cm		44cm		

# Kool Stride Running Stroller

This popular stroller for larger children with disabilities now has a unique advanced feature: an extendable rear wheel system. As the user grows, the rear wheels can extend backwards to maintain stability and control.

Lightweight all-terrain buggy for 10 year old to young adults



**Dual parking brakes**

**Carrier basket** under seat, and pocket on the back of the seat which can be used to hold drink bottles etc.

**5°, cambered large wheels** make walking **easy** on pathways, gravel or grass

**Lightweight aluminium frame**

**5-point safety anterior chest support**

**Weight limit of 60kg**



**Travelling made easy**

Quick release wheels for easy folding down, simple storage and transport.



Roll the sunhood side flaps up to let the cool air in

Stow the sunhood back

Folds flat and compact for transportation

## EXPLORE ...

Serious sports buggy for cruising outdoors!

- Jogging
- Bushwalks
- Beaches
- Farms

and much more...



## ACCESSORIES

**Rain Cover**  
2650-7600-010

**UV Cover**  
2650-7700-260



Code	Seat Depth	Seat Width	Shoulder Height	Seat Back Height	Foot Support Height	Overall Width	Max Load	Rear Wheel Diameter	Approx Stroller Weight
2650-0001-000	30cm	43cm	50cm	60cm	45cm	68cm	60kg	50cm	15kg







# Indoor Seating



We provide seating solutions that are designed to support children so they can play and learn. Our indoor seating range facilitates inclusion, whether at home or at school, ensuring children have endless opportunities to develop their skills.

Easy to adjust solutions with numerous accessory options ensure that tailored support is met with comfort and practicality.

---

Juni Chair	30
Zoomi+ High Chair	32
Gravity Chair	34
Cobra Base	35
Jenx Atom Chair	36
Jenx Junior+	38

---

# Indoor Seating Comparison Chart



SPECIFICATIONS	JUNI CHAIR				ZOOMI+ HIGH CHAIR	BINGO				BINGO SPEX	
	1	2	3	4		Mini	1	2	3	1	2
DESCRIPTION	Exceptional adjustment, along with a great range of optional accessories, your child's Juni can be tailored to them.				Ideal feeding chair for users who require extra postural support.	High & Low level seating for the BINGO.				High & Low level seating for the BINGO Spex.	
APPROX AGE OF USER*	18mths-12 years				4 mnth- adult	4mths-4yrs	1-5yrs	3-12yrs	8-15yrs	2-5yrs	3-7yrs
USER WEIGHT (kg)	30	40	50	60	85	25	50	50	50	50	50
SEAT WIDTH (cm)	24	28	32.5	36.5	43	13-25	18-30	23-35	23-35	17-28	22-33
SEAT DEPTH (cm)	18-24	22-30	26-36	32-42	15-26	12-27	16-34	22-40	27-45	18-30	23-38
BACK SUPPORT HEIGHT (cm)	26	29	32.5	40	27	37-51	45-63	54-75	62-83	36-44	40-48
FOOT SUPPORT HEIGHT (cm)		x			26-60	16-34	16-37	16-40	16-40	25-40	25-45
TILT IN SPACE		x			x			45° posterior			
RECLINE		x			x			70°			
GROWTH ADJUST SEAT		✓			✓	✓	✓	✓	✓	✓	✓
SEAT HEIGHT (cm)	16 - 22	20 - 28	24-34	30-40	40-65	27-61	27-61	27-61	27-61	27-61	27-61
HI LO OPERATION		x			x		Hand Operated Gas Assist				
TRAY		x			✓	✓	✓	✓	✓	✓	✓
POSTURAL SUPPORT LEVEL	Mild/Moderate				Mild/Moderate	Mild/Moderate/Complex					

\* Indicator only, for accurate product selection client measurements are the best guide. Medifab is as diligent as possible in compiling this information. Medifab does not guarantee the correctness and completeness of the information provided. Equally, Medifab does not guarantee that this information is up to date. For questions concerning our products, their specifications and their utilisation please refer to the instruction manual and/or a product consultant of Medifab. Product specifications are subject to change without notice.



GRAVITY CHAIR					JENX ATOM	JENX JUNIOR+ SEAT		
Sml	Med	Lrg	XLrg	XL-Wide		Size 1	Size 2	Size 3
Supportive alternative seating and foam positioning system to augment postural control for a wide range of individuals. Also used as a 'hugging' chair for individuals who benefit from this type of sensory input.					A modular seating system for users 6 months-5 years.	Comfortable, contoured and stable modular seating system, with outstanding levels of adjustment and a wide variety of support options.		
Refer to Measurements					6mths-5yrs	18mths-5yrs	3-8yrs	5-12yrs
50	70	100	130		25	50		
28 front 21 back	30 front 23 back	37 front 27 back	39 front 30 back	50 front 41 back	18-27	15-37.5		
24	30	38	43	43	9-34	21-30.5	24-35.5	26-44
60 total back	69 total back	74 total back	81 total back	81 total back	27-38	31.5-51	34.5-51	41-57.5
24 to floor	26 to floor	28 to floor	30 to floor		16.5-32.5 (Fixed Angle Foot Support) 11.5-36 (Flip Up Foot Support)	19.5-27	23-35	25-40.5
Use wedge underneath					Wooden Base: 20° posterior Y Base: 10° anterior-30° posterior	10° anterior-30° posterior		
✘					-15° - +15°	-15° - +15°		
✘					✓	✓		
N/A					28.5-75	29-76	33-76	36.5-76
N/A					Hydraulic Foot Pump	Hydraulic Foot Pump		
✓					✓	✓		
Mild/Moderate					Mild/Moderate/Complex	Mild/Moderate/Complex		

# Juni Chair

Whether in the classroom, nursery or at home, better posture while seated creates a more positive experience for your child. It can help develop fine motor skills, increase confidence and the ability to engage and learn.

## Confidence, engagement, learning



**Sturdy frame** helps to weight and prevent chair movements

**Gentle contouring** provides support and gives stability for sitting, promoting engagement and focus on the task at hand

**Juni's low seat to floor height** allows children to sit with their feet on the floor

**Tailor Juni to your child's needs:**

With exceptional adjustment of Juni, along with a great range of optional accessories, your child's Juni can be tailored to them, supporting them to achieve their goals and more!



### ACCESSORIES

**Side Cushions for Size 1 and 2 Juni**  
 25mm 3209-0001-025  
 50mm 3209-0001-050  
 75mm 3209-0011-050

**Side Cushions for Size 3 and 4 Juni**  
 25mm 3209-0003-025  
 50mm 3209-0003-050  
 75mm 3209-0013-050

**Standard Skis**  
 1 3209-5021-000  
 2 3209-5022-000  
 3 3209-5023-000  
 4 3209-5024-000

**Mobile Skis**  
 1 3209-5051-000  
 2 3209-5052-000  
 3 3209-5053-000  
 4 3209-5054-000

**Sliding Footboard**  
 1 3209-5071-000  
 2 3209-5072-000  
 3 3209-5073-000  
 4 3209-5074-000

**Adjustable and Foldable Table**  
 1 3209-7191-000 (Height 31-45cm)  
 2 3209-7192-000 (Height 40-60cm)

## Colour Options:

Base Package includes seat unit and hip belt. Available in four colours.



Black (-099)



Blue (-060)



Red (-022)



Lime (-054)

Size	Code	Seat Height	Seat Width	Seat Depth	Back Support Height	Weight Capacity	Product Weight
1	3209-1001-0XX	16-22cm	24cm	18-24cm	26cm	30kg	4kg
2	3209-1002-0XX	20-28cm	28cm	22-30cm	29cm	40kg	6kg
3	3209-1003-0XX	24-34cm	32.5cm	26-36cm	32.5cm	50kg	8kg
4	3209-1004-0XX	30-40cm	36.5cm	32-42cm	40cm	60kg	10kg







# Zoomi+ High Chair

Zoomi+ is the ideal feeding chair for children and adults who require a little extra postural support. With its height adjustable foot support, seat and back support it can be individually tailored for growth and changing needs. It can be easily manoeuvred from room-to-room, enable mealtime inclusion and provide the user with greater comfort.

The one-size-fits all feeding chair for all ages!



**Wipe-clean surfaces** as standard make cleaning easy

**Sturdy frame** design provides stability and prevents chair movements

**Gentle contouring** provides support and gives stability

**Quick-release tray** supports upper limbs while providing a space for activities

**Mobile skis and an integrated handle** mean the Zoomi+ can be moved around home with ease

## ACCESSORIES

**Centrepoint Harness**  
**0** 1409-5660-017 (Pad height 22cm)  
**1** 1409-5661-017 (Pad height 28cm)



**2-Point Hip Belt X-Small**  
 1405-6220-027 (Pad width 30cm)



**Transfer Step**  
**Black** 3212-5901-099  
**Blue** 3212-5901-060  
**Red** 3212-5901-022  
**Lime** 3212-5901-054



**Extended Slotted Footboard**  
**Black** 3212-5021-099  
**Blue** 3212-5021-060  
**Red** 3212-5021-022  
**Lime** 3212-5021-054



**Extended Contoured Padded Seat**  
**Black** 3212-8991-099  
**Blue** 3212-8991-060  
**Red** 3212-8991-022  
**Lime** 3212-8991-054



### Zoomi+ Package Contains:

- Seat Unit
- High Back Support
- Contoured Padded Seat
- Arm Supports
- Foot Support
- Mobile Skis
- 5-Point Harness
- Quick-Release Tray

### Colour Options:



Black (-099)

Blue (-060)

Red (-022)

Lime (-054)

### ANTI-MICROBIAL PROPERTIES

The Zoomi+ wooden frame has anti-microbial properties that ensure surfaces are kept hygienic, which helps to reduce any risk of cross-infection and is especially useful in multi-user environments such as nurseries and schools.



Code	Frame Height	Seat Width	Frame Depth	Seat Depth	Back Pad Height	Foot Support Height	Weight Capacity	Product Weight
3212-1001-OXX	81cm	43cm	55cm	15-26cm	27cm	26-60cm	85kg	16kg

# Gravity Chair

Supportive and easy to use chair for time relaxing indoors whilst protecting posture and providing comfort. The Gravity Chair follows the principle of 'Tension and Relaxation' providing not only a comfortable seat, but an alternative and stable solution for users who otherwise might have spent time on the floor or sofa for relaxation. The Gravity Chair provides a snug and 'safe' feeling for users who have a need for increased sensory feedback.

## More than just a comfortable seat...



**Centre of gravity** is very low to offer a stable seating position

**Very light**, which enables it to be used almost anywhere

**Simple Yet Customisable** the gravity chair has a range of accessories for offering more support

Deep seating configuration **utilises gravity** to provide a stable and supportive environment

**Deep Lateral Side Supports** help to not only support the users posture, but also provide high levels of contact which some users find beneficial

### Standard configuration

- Breathable seating insert with four liner colour options available: Black (-099) Blue (-066), Green (-055), Red (-022).
- Choice of breathable or incontinence proof cover
- Standard head support
- Hip belt
- Velcro attached side pouch
- Tilt wedge
- Adjustable Pelvic Positioning Belt

### Client group

- Users with limited ability to sit by themselves can be comfortably supported in the Gravity Chair.
- If users spasm, the Gravity Chair absorbs this force, allowing for some movement. After the spasm, the chair brings the user back into the original position.
- Users get close body contact in the Gravity Chair, great for proprioceptive feedback and self-awareness. The Gravity Chair can create an optimal solution for many occupational therapy requirements.
- The Gravity Chair is great for some users who may be mobile, but where mobility requires a lot of energy. The Gravity Chair can be used to support relaxation and comfort when needed as an alternative to less supportive options.



### ACCESSORIES

**Mobile Base**  
**S** 3780-8701-000  
**M** 3780-8702-000  
**L** 3780-8703-000  
**XL** 3780-8704-000  
**XLW** 3780-8705-000



**Therapy Tray**  
**Small/Medium** 3770-7201-000  
**Large/X-Large** 3770-7202-000  
**XL-Wide** 3770-7203-000



**Standard Lateral Head Support**  
**Sml** 2010-4210-XXX  
**Lrg** 2010-4211-XXX





**Extended Lateral Head Support**  
**Sml** 2010-4310-XXX  
**Lrg** 2010-4311-XXX



**Occipital Head Support**  
 2010-4110-XXX



**Head Support Fabric Options:**

-  **Merino/Spacer** -099
-  **Wipe Down** -209

**Foot Support**  
**Small/Medium** 3770-1031-000  
**Large/XL/XL-Wide** 3770-1032-000

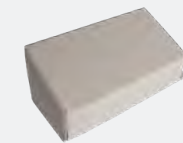

**Abductor Pommel**  
**Small/Medium** 3770-1021-000  
**Large/XL/XL-Wide** 3770-1022-000



**Side Filler Pads**  
**Sml** 3770-1011-000  
**Med** 3770-1012-000  
**Lrg** 3770-1013-000  
**XL/XL-Wide** 3770-1014-000



**Depth Adj Liner**  
**Sml** 3770-0321-000  
**Med** 3770-0322-000  
**Lrg** 3770-0323-000  
**XL** 3770-0324-000  
**XL-Wide** 3770-0325-000



Size	Code	User Height	Seat Depth	Seat Width At Back	Seat Width At Front	Back Height	Chair Total Width	Chair Total Height	Chair Total Depth
Sml (1)	3770-00X1-XXX	90-110cm	24cm	21cm	28cm	60cm	46cm	55cm	60cm
Med (2)	3770-00X2-XXX	110-130cm	30cm	23cm	30cm	69cm	49cm	61cm	71cm
Lrg (3)	3770-00X3-XXX	130-150cm	38cm	27cm	37cm	74cm	57cm	67cm	82cm
XLrg (4)	3770-00X4-XXX	150-170cm	43cm	30cm	39cm	81cm	60cm	71cm	91cm
XL-Wide (5)	3770-00X5-XXX			41cm	50cm		71cm	72cm	

# Indoor Bases for Stroller Seat Units

Height-adjustable indoor bases are available for the BINGO Mini, BINGO Evo, and BINGO Spex, where the removable seat units can be removed from the stroller base and attached to the indoor base with ease. Height-adjustable features are quick and easy to change allowing the height of the seat to be lowered to the floor for peer interaction or raise to the dinner table to make mealtimes enjoyable for the whole family.

## Cobra Base

Height-adjustable indoor base to suit the **BINGO Mini** (see pg 15), **BINGO Evo** (see pg 17), and **BINGO Spex** (see pg 19) seat units.



Size	Code	User Age	Max Load	Approx Product Weight	Tilt	Seat Height	Total Length	Total Width
1	2880-8711-000	1-5 years	50kg	11.3kg	45°	27-61cm	71cm	61cm
2	2880-8721-000	3-15 years	50kg	11.5kg	45°	27-61cm	71cm	61cm

# Jenx Atom Chair

Modern, child-centred styling, combined with a comprehensive range of support options make Atom the ideal seating system to develop correct sitting posture and function.

## A modular seating system for users 6 months to 5 years



Y base provides a **range of seated height options** to suit both floor level and table top activities

**Colour choice of red or pink**

**Open sides** ensures adjustments are easily made with the user remaining seated

**Tool free adjustments,** cleverly designed wing knobs offer a comfortable grip to enable effective clamping with minimal effort

**Unrivalled seat depth growth** to accommodate early intervention requirements

**Memory foam ischial well** designed to nestle the pelvis. Provides comfort, pressure distribution and stability to promote correct pelvic alignment

### RED PACKAGE:

- Padded seat with memory foam
- Shaped back pad
- Arm supports
- Nursery tray
- Adjustable flip away hip support pads
- Push Handle
- Upper back pad
- Flip up angle adjustable footplate

3431-1001-022



### Y-Base:

- Versatile and flexible, with lockable swivel castors
  - High-low range of 25.8-75cm seat height from floor
  - Tilt from 30° recline - 10° prone
  - Base footprint of 65 x 78cm
- 3615-8740-000



### PINK PACKAGE:

- Padded seat with memory foam
- Shaped back pad
- Adjustable flip away hip support pads
- Push handle
- Upper back pad
- Arm supports
- Tray table support
- Shoulder protractors
- High rise flexi thoracic pads
- Thoracic pad covers
- 2 Link Multigrip Head Support
- Flip up angle adjustable footplate

3431-0010-028



### Functional benefits:

- **Head Positioning:** Through the innovative Multigrip Head Support, there are a number of solutions that adapt to varying head positioning needs.
- **Trunk Positioning:** All trunk positioning accessories are optional and are intended to offer just the right level of support.
- **Leg Positioning:** With a number of different control options windsweeping, abduction and adduction can be easily influenced or controlled using our standard leg positioning accessories.
- **Foot Positioning:** The child's feet can be precisely positioned using a number of accessories.

Colour	Code	Approx Age Range	Max User Weight	Tilt	Back Pad Height	Chest Width	Hip Width	Seat Depth	Lower Leg Length	Foot Support Angle
Red	3431-1001-022	6mths - 5yrs	25kg	15° - 15°	27-38cm	20-28cm	18-27cm	9-34cm	16.5-32.5cm	5° - 35°
Pink	3431-0010-028									

# Jenx Atom Accessories

**Multigrip Head Support**  
1 Link 3431-4601-022  
2 Link 3431-4602-022



**Multigrip Head Support**  
1 Link Wipeable Cover 5356-4671-000  
2 Link Wipeable Cover 5356-4672-000



**Shoulder Protractors**  
3431-2750-022



**Sacral Block**  
3431-2501-000



**Back Pad Infill**  
3431-2370-000



**High-Rise Flexible Thoracic Support Pads**  
3431-3251-022



**High-Rise Short Thoracic Support Pads**  
3430-3151-000



**Nursery Tray Infill**  
3431-7182-000



**Half Padding**  
3431-7442-000  
**Full Padding**  
3431-7452-000



**Activity Frame**  
3615-7475-000  
**Grab Rail**  
3615-7200-000



**3 Point Lap Strap**  
3431-6251-000  
**Spex 4 Point Lap Strap**  
1406-6420-027



**Waistcoat Harness**  
3615-6701-000



**Wonderseat Centrepoint Shoulder Harness:**  
Size 0 1409-5660-017



**Wonderseat 4-Point Hip Belt:**  
1406-5420-027



**Abduction Block**  
Size 0 3615-1650-000  
Size 1 3615-1651-000



**Long Leg Sitting Board**  
3431-0281-022

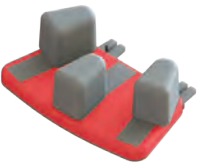

**Leg Control Pads**  
3431-1751-000



**Sandals**  
5356-6081-000



**Ankle Snugs**  
5356-6131-000



**Sandal Raising Blocks**  
5356-6091-000



**Shoulder Protractors**  
3431-2750-022



**Elbow Blocks**  
3730-7350-000

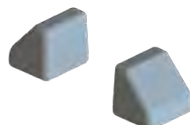

**Foot Support Pad**  
3431-5701-000

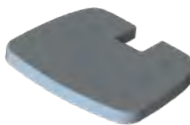

# Jenx Junior+

Comfortable, contoured and stable modular seating system, designed for children with mild to complex posture support needs. Outstanding levels of adjustment with a wide variety of support options.

## Functionality, flexibility and style

Carefully designed to draw attention to the child rather than the equipment itself





Pelvic control system with independently adjustable contoured seating

Flip-up angle adjustable foot support to accommodate dorsiflexion or plantar flexion

All support pads and accessories are designed to quickly & easily flip away without being removed

**Standard Package Includes:**

Contoured PU seat with removable abduction pad and memory foam seat pad, adjustable and flip-away PU hip pads, angle-adjustable footplate, 4-point hip belt, height-adjustable PU back pad, an independently adjustable PU lumbar/sacral pad, arm supports, tray table and push handle.



**Y-Base:**

- Versatile and flexible, with lockable swivel castors
- High-low range of 25.8-75cm seat height from floor
- Tilt from 30° posterior - 10° anterior
- Base footprint of 65 x 78cm

3615-8740-000



Low seat-to-floor height for peer interaction.



Ease of transfer with tilt and swing-away supports.



Open design for comfort and support.

### ACCESSORIES

**Multigrip Head Support**  
1 Link 5356-4601-000  
2 Link 5356-4602-000  
3 Link 5356-4603-000



**Waistcoat Harness**  
1 3615-6701-000  
2 3615-6702-000  
3 3615-6703-000



**Abduction Block**  
0 3615-1650-000  
1 3615-1651-000



**Shoulder Protractors**  
0 3612-2750-000  
1 3612-2751-000  
2 3612-2752-000



**Flexi Lateral Supports**  
1 3615-3251-000  
1 (Long) 3615-3252-000  
2 3615-3253-000



**Activity Frame**  
3615-7475-000



**Tray Infill**  
1 3610-7180-000  
2 3610-7182-000



**Tray Elbow Blocks**  
3615-7350-000



**Back Post Extension**  
3610-2480-000



**Hip Width Reducing Pads**  
3612-1040-000



**Wipeable Cover, Blue**  
1 3612-0521-W66  
2 3612-0522-W66  
3 3612-0523-W66



**Wipeable Cover, Red**  
1 3612-0521-W22  
2 3612-0522-W22  
3 3612-0523-W22



Size	Code	Approx Age Range	Max User Weight	Back Angle	Seat Width	Seat Depth	Back Support Height	Lower Leg Length
1	3612-0001-000	18mths-5yrs	50kg	15° recline	15*-37.5cm	21-30.5cm	34.5-51cm**	19.5-27cm
2	3612-0002-000	3-8yrs				24-35.5cm	34.5-51cm**	25-35cm
3	3612-0003-000	5-12yrs				26-44cm	41-57.5cm**	25-40.5cm

\* 15cm achieved only when using the hip reducing pads.  
\*\* 51cm back height in Size 1 + 2 and 57.5cm in Size 3 only achieved with back post extension.









# Therapy



Use versatile therapy aids to create play opportunities, provide support and rest, and promote motor development through crawling, sitting and balancing for greater overall participation.

---

Jenx Corner Seat	42
Jenx Nursery Table & Therapy Bench	43
Jenx Ly-on	44

---

# Jenx Corner Seat

Bright and comfortable, an ideal first seat for any child, that also suits infants and young children. Offers support in long sitting, which is children's usual first sitting position.

## Adjustable floor based seating system

Sturdy wings and corner shape helps to **maintain a midline position** with symmetry of the child's spine



**Adjustable Height Back Support** can be used with or without the upper back support to support head or shoulders

**Standard Pelvic Support Belt and Adjustable Medial Thigh Support** help stabilise the pelvis and lower limbs

Small 'touch and close' tape straps keep the Corner Seat **safely connected** to the nursery table while in use

### Sitting Benefits

- Long sitting, with the legs stretched out in front, helps to maintain the length of the muscles behind the knee.
- Great working space for peer group interaction and plenty of fun activities including working and playing with other children.



### NURSERY TABLE

- Effective when used together with the Corner Seat.
- Adaptable work surface which can be used flat, angled or as an easel.
- Continuous height adjustment to allow the precise and correct height.
- A short strap attaches to the Corner Seat to prevent a child tipping the table over.
- Easy to wipe clean, with cut out to allow the child to get close to the tabletop activities.
- Bright and contrasting edging around the surface reduces the risk of objects sliding off and provides a place for toys to be secured to.



See opposite for codes and sizes.

### ACCESSORY

#### Triangular Cushions

For when a flat back with wings is preferred. Fit all seat sizes. Can also be used beside legs to prevent external rotation.

**Lime**  
3140-2450-054

**Blue**  
3140-2450-066



Size	Code	Approx Age Range	Back Pad Height	Seat Depth	Max User Weight	Base Size	Colour
1	3140-0041-054	6mths - 2yrs	31.5 - 42.5cm	35cm	25kg	49 x 50cm	Lime
2	3140-0042-054	1-6yrs	44 - 62cm	37cm	35kg	52 x 54cm	Lime
3	3140-0044-066	4-10yrs	50 - 68cm	46cm	55kg	60 x 63cm	Blue

# Jenx Nursery Table

Effectively used in conjunction with the Jenx Corner Seat and Jenx Therapy Bench, the Jenx Nursery Table is available in 3 sizes to suit children from 9 months to 6 years old.

## Adaptable Work Surface

Height adjustable surface can be used flat, angled or as an easel



Large surface big enough for play or work activities

Smooth, sturdy and wipe clean surface, ideal for drawing and writing activities

## USED IN CONJUNCTION WITH CORNER SEAT



Size	Code	Base Size	Table Top Angle Range	Table Top Size	Table Height
0	3140-7101-000	60.5 x 38cm	+40° to -40° from horizontal	51 x 60.5cm	19-28cm
1	3140-7102-000	60.5 x 38cm		51 x 60.5cm	24.5-34.5cm
2	3140-7103-000	70 x 42cm		51 x 70.5cm	29-44cm

# Jenx Therapy Bench

Ideal platform for a variety of different activities such as sitting and balance therapy, dynamic sitting balance and sitting posture improvement

## Therapy aid designed to promote upright sitting and balance

Easily height adjustable using tightening bolt



Easy to clean, antimicrobial, wipe-down vinyl cushions

Interchangeable cushions include the standard 1" flat cushion and the half round cushion

The simple design means that the Therapy Bench can be easily moved with just 1 hand

## ACCESSORIES

Half Round Cushion  
Size 1 7510-0501-054  
Size 2 7510-0502-054



Pelvic Support  
7510-1900-054



Abduction Block  
7510-1750-054



Knee Blocks  
Size 1 7510-1601-054  
Size 2 7510-1602-054



Size	Code	Max Load Weight	Bench Height from Floor	Bench Top Length	Bench Top Width	Flat Cushion Width	Flat Cushion Length	Flat Cushion Depth
Size 1 - Full Length	7510-0010-054	85kg	16.5-25cm	98cm	20cm	25cm	100cm	25cm
Size 1 - Half Length	7510-0015-054	85kg	16.5-25cm	48cm	20cm	25cm	50cm	25cm
Size 2 - Full Length	7510-0020-054	85kg	23.5-39.5cm	98cm	25cm	30cm	100cm	25cm
Size 2 - Half Length	7510-0025-054	85kg	23.5-39.5cm	48cm	25cm	30cm	50cm	25cm

# Jenx Ly-on

Modern support system for children and young people who access lying positions during the day time. This highly adjustable solution ensures that the user can remain included whilst accessing the lying position they need.

## Feeding, Education and Access Station for users up to 70kg

**Activity Frame and Tablet Holder** easily clip into place allowing the user to be entertained during long periods of lying.

**Standard with a wide range of height adjustment** – supporting children to engage in low to the floor activities whilst also being able to be correctly positioned for even the tallest of carers

**15° tilt recline and forward** allows for weight distribution to be altered to aid in pressure management.



**Side Lying Straps** offering controlled positioning at the chest or pelvis.

**Fold down sides**, allowing for easy engagement with the child and also making transfers in and out of Ly-on safe and dignified.

**Removable and washable** at 60°, this accessory sheet allows for precise positioning of the various support options.

### STANDARD PACKAGE INCLUDES

- 4 lockable castors
- Hydraulic lift action
- Tilt-in-space mechanism
- Fold down side walls with padded green vinyl
- Memory foam topped lying surface (covered with grey wipe clean PU material)
- Hook receptive sheet with stabilising tabs
- Push handle
- Multiple postural support accessories for variety of support and positioning needs
- Accessory storage box and cart
- Activity frame with tablet holder



Activity Frame/  
Tablet Holder



Height Adjustable  
Platform



Support Blocks  
and Straps



Hooks and Loop  
Receptive Sheet



Fold Down  
Sides



Code	Max. User Weight	Max. User Height	Tilt	Support Platform Dimensions	Side Wall Height (3 sizes available)	Foot Support Dimensions	Height From Floor	Product Weight
7520-0015-054	70kg	160cm	15°- 15°	168 x 56cm	20/25/30cm	196x67cm	52-101cm	76kg

# Jenx Ly-on Accessories

**Extra Hook Receptive Sheet**  
7520-7000-000



**Extra Hook Tab**  
7520-7050-000



**Side Wall:**  
Size 1: 7520-7211-054  
Size 2: 7520-7212-054  
Size 3: 7520-7213-054



**Side Lying Strap:**  
Size 1: 7520-1871-000  
Size 2: 7520-1872-000  
Size 3: 7520-1873-000



**Rotation Control Strap:**  
Size 1: 7520-1881-000  
Size 2: 7520-1882-000  
Size 3: 7520-1883-000

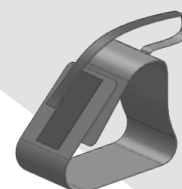

**Rotation Control Frame**  
7520-1870-000



**Accessory Mount**  
7520-7925-000



**Activity Frame:**  
Size 1: 7520-7911-000  
Size 2: 7520-7912-000



**Tie-on Beam**  
7520-7920-000



**Tablet Holder**  
7520-7930-000



**Triangular Shelf Block**  
7520-7750-000



**Triangular Positioning Block**  
7520-1850-000

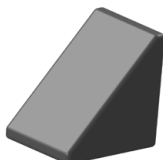

**Bridge Block:**  
Size 1: 7520-7441-000  
Size 2: 7520-7442-000  
Size 3: 7520-7443-000

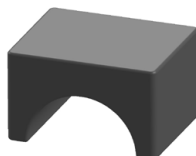

**Half Roll Block:**  
Size 1: 7520-7821-000  
Size 2: 7520-7822-000

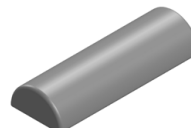

**Roll Pillow**  
7520-7800-000

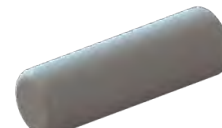

**Flat Oval Pillow**  
7520-7500-000

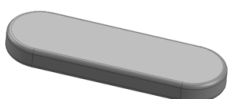

**Accessory Cart**  
7520-7950-000



**Accessory Box**  
7520-7940-000

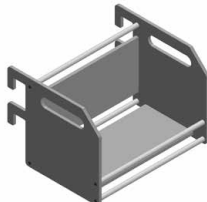

Making travel  
easy and safe



## Vehicle Seating



Passengers with disabilities and medical conditions often require additional supports to maintain their safety and comfort when travelling. Our comprehensive range provides support for posture and positioning through to behaviours of concern.

---

Carrot 3000 Car Seat	50
Carrot XL Car Seat	52
Hero-NXT Car Seat	54
Starlight-NXT Car Seat	55
Ipai-LGT Car Seat	56
Kidsflex Car Seat	57

---

# Vehicle Seating Comparison Chart



SPECIFICATIONS	CARROT		HERO-NXT	
	3000	XL	With Std Cushion	Without Std Cushion
DESCRIPTION	Extension accessories and multi-adjustable features allow longer use.		Swivelling special purpose car seat for forward or rear facing.	
USER WEIGHT RANGE (kg)	13.6 – 49	36 – 75	0-18	
SEAT WIDTH (cm)	31	51	21	25
SEAT DEPTH (cm)	25 – 40	38 or 42	25	28
SHOULDER HEIGHT (cm)	32 – 57	49.5 – 62	24-34	27-35
APPROX PRODUCT WEIGHT (kg)	8.7	10.5	16	
TILT IN SPACE	Using wedge	Using wedge	✓	
SWIVEL BASE (Car requires ISOFIX)	✓	✗	✓	
GROWTH ADJUSTABLE	✓	✓	✓	
FOOTPLATE	✓	✗	✗	
TRAY/FOREARM SUPPORT	✓	✓	✓	
POSTURAL SUPPORT LEVEL	Mild/Mod/Complex	Mild/Mod/Complex	Mild/Mod/Complex	
IS ISOFIX REQUIRED IN VEHICLE?	Only required for Swivel Accessory	Optional	Essential	
REAR FACING CAPACITY	✗	✗	✓	
SUPPORT/PAD OPTIONS	✓	✓	✓	
STANDARD/REGULATION COMPLIANCE	ECE R44 & FMVSS 213	Medical Device Regulation (EU) 2017/745	ECE r129	
ANTI-ESCAPE OPTIONS	✓	✓	✗	
RECLINE	✓	✓	✗	





STARLIGHT-NXT		IPAI-LGT	KIDSFLEX	
Standard	With XL Kit		2	3
Excellent posture support option with tilt and swivel functions.		Lightweight, adjustable special purpose restraint with postural support.	Fully adjustable specialised seating with excellent posture support options.	
9 - 36		15 - 36	36	75
30		31	35	40
26	32	32	34 - 39	40 - 46
32 - 42	44 - 53	38 - 58	41 - 57	47 - 65
13.5		7	8.9	12.3
✓		Using wedge	✓	
✓		✗	✓	
✓		✓	✓	
✗		✗	✓	
✓		✓	✓	
Mild/Mod/Complex		Mild/Mod	Mild/Mod/Complex	
Essential		Optional	Essential	
✗		✗	✗	
✓		✓	✓	
ECE r44		ECE r44	Medical Device Regulation (EU) 2017/745	
✗		✗	✗	
✗		✓	✓	

\* Indicator only, for accurate product selection client measurements are the best guide. Medifab is as diligent as possible in compiling this information. Medifab does not guarantee the correctness and completeness of the information provided. Equally, Medifab does not guarantee that this information is up to date. For questions concerning our products, their specifications and their utilisation please refer to the instruction manual and/or a product consultant of Medifab. Product specifications are subject to change without notice.

# Carrot 3000 Car Seat

# CARROT 3

Various extension accessories and multi-adjustable features allow for growth and adaptation as a child's needs change over time. The Carrot 3000 caters for safety and the importance of keeping the child in a supported posture for travel.

## Our most comprehensive special needs car seat

**Ergonomically designed head support** holds the head and protects from side impacts and centrifugal forces

**Shoulder protector wings:** Extendable wings hold and protect the body from side impacts and centrifugal forces

**Large chest support** holds the body securely

**Recline function** with angle adjustable seat and back support

**Tether options** include additional security tether for the top of back support or ISOFIX latch connectors.

2 positions of **seat depth adjustment** for a better fit

### STANDARD PACKAGE INCLUDES

- Carrot seat unit
- 5-point anterior chest support
- Headrest wings
- Tee-pad
- Free recline back support



The Carrot 3000 conforms to EU regulation ECE R44/04 and FMVSS 213 standard.

If user is too large for the Carrot 3000 Car Seat, the Carrot XL Seat is available for larger users – see page 52.

## Huge growth for pre-schoolers to older children

When requesting quote, please specify the user's shoulder height and seat depth.

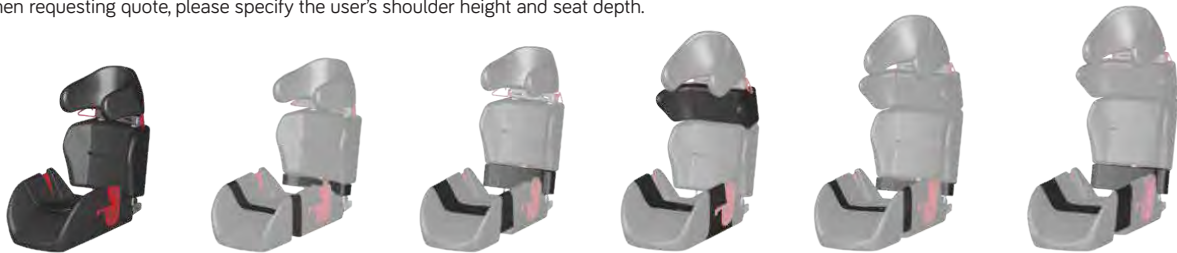

Size	Code	Age Range	User Weight Range	Seat Depth	Seat Width	Shoulder Height	Foot Support Height	Seat Weight
Small	4116-0010-259	3-15 years	13.6-49kg	25-40cm	31cm	32-57cm (when shoulder protector wings are added)	Small = 25-30cm Medium = 30-40cm Large = 40-50cm	8.7kg



### Air Travel Friendly

The Carrot 3000 Car Seat has been approved for use in aircraft of some major airlines including the Federal Aviation Administration in the USA. This is NOT a guarantee that your chosen airline will allow the Carrot 3000 Car Seat to be used in their aircraft, and you must contact the airline prior to flying.

# Accessories

**Swivel Base Attachment\***  
4116-0180-104

**Swivel Base Protection Plate**  
4116-0190-000

\*Standard adjustment of mandatory footprop is 34cm-40cm  
\*Requires ISOFIX



**Foot Support**

**Sml lower leg (D): 25-30cm**

4116-5241-250

**Med lower leg (D): 30-40cm**

4116-5242-250

**Lrg lower leg (D): 40-50cm**

4116-5243-250



**Swivel Base Floatplate Adaptor**

4116-5120-000



**Seat Belt Holder**

4116-6790-017



**Removable Incontinence Cover**

4116-0475-209



**Rodded 50mm Seat Depth Pad**  
4116-0281-259

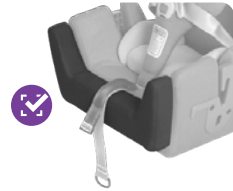

**100mm Rodded Waterfall Seat Base Extension**  
4116-0283-259



**50mm Seat Depth Growth Pad**  
4116-0285-259



**100mm Seat Depth Growth Pad (only with Waterfall)**  
4116-0289-259

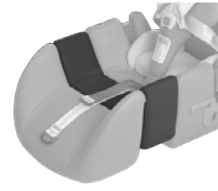

**Abduction Pad**  
4116-1510-000



**50mm Back Support Height Extension Infill Pad**  
4116-2481-259



**100mm Back Support Height Extension Infill Pad**  
4116-2482-259



**Shoulder Protector Wings**  
4116-2753-259



**Anti-Escape Anterior Chest Support**  
4116-6026-259



**Shoulder Strap Retainer**  
Small: 4116-6721-000  
Medium: 4116-6722-000  
Large: 4116-6723-000



**Pen Release Anterior Chest Support**  
4116-6025-259



**Cross Strap Anterior Chest Support**  
Anti-Escape 4604-3004-026  
Pen Release 4604-3004-025  
Side Release 4604-3112-019



**Tether Strap**  
4116-6953-017



**ISOFIX Lower Straps**  
4116-6910-000



**Hinge Lock Belt (for easy carrying)**  
4116-8170-000



**Tray / Forearm Support**  
4116-5534-259

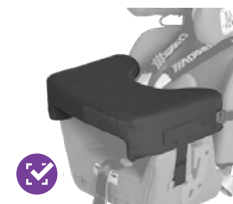

**Tilt Wedge**  
4116-0291-259



**Firm Contoured Lateral Trunk Support Wedges**  
4116-3250-090



**Air Mesh Cushion Pad**  
4116-8880-099



**Deeper Headrest/ Larger Tee Pad**  
4116-0000-259



# Carrot XL

# CARROT 3

Carrot XL caters for safety and the importance of keeping the user in a supported posture for travel. This larger sized car seat is suitable for older children and adult users who will not fit into the Carrot 3000.

## Larger version of the popular Carrot 3000 Car Seat



**Extendable shoulder protector wings** hold and protect the body from side impacts and centrifugal forces

**Ergonomical large head support**

**Special large anterior chest support** design with easy length adjustment to support the shoulders of older users

**Correct pelvis alignment** with comfort padded hip belt

**Low profile wide seat base**

### UPGRADE KIT

Upgrade an existing Carrot 3000 to XL.

Carrot XL Upgrade kit can be purchased to **upgrade an existing Carrot 3000 Car Seat** to an XL version, instead of purchasing a whole new car seat when the child grows out of the existing seat.



Kit includes:

- XL Low profile wide Seat Base
- Longer metal rods for base
- H-Anterior Chest Support
- Hip belt

4116-0030-259

*Please note that the XL Upgrade Kit must be fitted by Medifab Ltd or an authorised Medifab distributor.*

### Package includes

- Low contour seat base
- Back support
- 50mm height extension
- Deep headrest
- Width adjustable shoulder protector wings
- 4 point H anterior chest support



### FUNCTIONAL BENEFITS

- Equipped as standard with the low profile wide seat base, large size headrest, shoulder protector wings, and 50mm back support extension.
- Extendable shoulder protector wings hold and protect the body from side impacts and centrifugal forces.
- Tether options include additional security tether for the top of back support or ISOFIX latch connectors. These may be required by your local authorities.

If user is too small for the Carrot XL Car Seat, the Carrot 3000 Car Seat is available for smaller users – see page 50.

**The Carrot XL conforms to regulation (EU) 2017/745 on medical devices.**

Code	Age Range	User Weight Range	User Height Range	Seat Depth	Seat Width	Shoulder Height	Seat Weight
4116-0020-259	10 to Adult	36-75kg	140cm - 175cm	38 or 42cm	48cm	495 - 62cm	10.5kg

\*When Shoulder protector wings added.

# Accessories

**Tether Strap**  
4116-6953-017



**ISOFIX Lower Straps**  
4116-6910-000



**Pen-Key Release Harness Belt**  
4116-6125-256



**Tilt Wedge**  
4116-0291-259



**100mm Back Support Height Extension Infill Pad**  
4116-2482-259



**Forearm Support Tray**  
4116-5544-259



**Lateral Trunk Supports**  
4116-3250-090



**Air Mesh Cushion Pad**  
4116-8880-099



**Hipbelt (Seat Base)**  
Medium 4116-6532-027  
Large 4116-6533-027



**Crotch Belt**  
(requires customisation of seat base)  
4116-6320-000

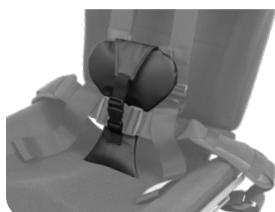

**Airplane Fixing Strap**  
4116-6960-017



# Hero-NXT Car Seat

The Hero-NXT child car seat is Australia's only rear facing special purpose car seat, designed to accommodate the postural requirements of young children with additional needs. It is suitable for installation in most commercially available vehicles that have an ISOFIX connection. The car seat is designed for use on the back seat of the car. Due to its swivel base, the vehicle needs to have ISOFIX for installation.

## Swivelling car seat for forward or rear-facing



### ACCESSORIES

**Security Tray**  
4181-5530-000



### FUNCTIONAL BENEFITS

- The Hero-NXT can be used both forward and rear-facing direction.
- To support children with limited upper body control, the Hero-NXT has a tilt function to adjust the seat angle.
- The Hero-NXT is equipped with its own 5-point chest and shoulder strap that securely holds your child in place.

### Package includes:

- 10° tilt with swivel base 360°
- Rear/Forward facing position
- Five-point harness
- Back support (height adjustable)
- Adjustable lateral supports as standard

## Practical and functional



In direction of travel; adjustable back height



Rotatable by 90° in either direction for easy transfers



In rearward position



Adjustable Lateral Supports fitted as standard

Code	Seat Width (knee)	Seat Width (pelvis)	Seat Depth	Back Height	Crown Height	Distance Laterals	Total Height	Total Width	Total Depth	Capacity
4181-0010-020	28cm	21cm	25cm	21cm	41cm	12cm	66cm	43cm	63cm	18kg
				34cm	53cm	21cm	73cm			

\*Measurements with standard cushion

# Starlight-NXT Car Seat

Fully adjustable special purpose car restraint, offering excellent posture support options and an inbuilt tilt function. Starlight-NXT is suitable for young children from 9kg, and will grow with the child right up to 36kg. Due to its swivel base, the vehicle needs to have ISOFIX for installation.

## Excellent postural support

**Inbuilt adjustment** to the rear of the seat allows the backrest height to be increased for growth

**XL upgrade kit** provides long term growth and use

**Crash tested** to ECE R44-04



**Lateral supports with built in adjustment**, meeting the postural needs of the user

**5 point comfort harness** with shoulder and abdominal padding, and centre pull adjuster

## ACCESSORIES

**Forearm Support Tray**  
4141-5530-000



**Abduction Pommel**  
4141-1510-000

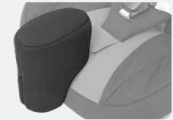

**XL Upgrade Kit**  
4141-0140-000

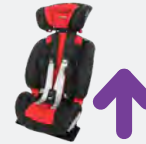

Inbuilt Cup Holder

## Package includes:

- Adjustable headrest
- Backrest infill padding
- Slim lateral supports
- 20° tilt
- Base board accessory
- Swivel base system - (Left turning) to enable turning of the car seat towards the doorway to help with transfers
- ISOFIX seat attachment
- Grey/Black upholstery



**SLIM SWIVEL BASE**  
Allows more space and headroom inside the car when turning out.

Code	Seat Width (pelvis)	Seat Width (knee)	Seat Depth (min-max)	Back Height	Crown Height	Height Laterals	Distance Laterals	Car Seat Weight	Capacity
4141-0011-090	30cm	35cm	26cm	27-39cm	51-62cm	17-27cm	14-19cm	8.5kg	9-36kg

\*Reducer cushion available

# Ipai-LGT Car Seat

The Ipai-LGT lives up to its name, characterised by a light weight easy-to-use design and providing mild body support and care for children with additional needs. Comes standard equipped with ISOFIX (for additional stability during transfers), thoracic supports and a 5-point harness that is padded at the shoulders. The large, stable tee pad within the lower portion of the harness assists in providing firm support across the child's pelvis.

Light weight, comfortable and safe!



**Side Impact Protection System**

**Simple height adjustment** providing comfort and safety

**Lightweight option** making transfer between vehicles easy

**5 point comfort harness** comes as standard

## ACCESSORIES

**Ipai-LGT Padded Tray Table**  
4080-5411-000

**Tilt Wedge**  
4116-0291-259



## FUNCTIONAL BENEFITS

- Simple height adjustment function allows the backrest 20cm of height range providing greater comfort and safety for the child.
- IPAI-LGT comes with ISOFIX connection points which can be used to provide additional stability to the seat during transfers. ISOFIX is not required for installation of the IPAI-LGT.
- Have the peace of mind that your child is kept safe with the Side Impact Protection System that can be unscrewed to secure the car seat against the side of the vehicle door, improving safety in the event of side impact to the vehicle.

### Package includes:

- Supportive 5 point harness with dual adjustment
- Backrest height adjustable
- Adjustable lateral supports



Backrest Height



Adjustable depth ISOFIX, optional use for additional stability



Side Impact Protection System

Code	Seat Width (rear)	Seat Width (front)	Seat Depth	Back Height	Head Support Height	Lateral Support Height	Distance between Laterals	Back Support Recline Angle	Total Height	Overall Width	Total Depth	Total Weight	Capacity
4081-0011-060	31cm	34cm	32cm	38-58cm	59-79cm	20-33cm	14-28cm	85°- 162°	67-85cm	48cm	39cm	7kg	36kg



# Kidsflex Car Seat

Excellent posture support options and suitable for installation with most car types with ISOFIX. Available with a range of options and adjustments, allowing complete comfort and postural management for the child. Due to its swivel base, the vehicle needs to have ISOFIX for installation.

## Fully adjustable specialist seating

Secure seat using the existing **3 point safety belt** fitted in the rear seat.

**5 point harness** comes standard with abdominal padding



**Adjustable tilt angle and back support recline** can be tailored to suit the users postural needs

**Slimline seat cushions** allow more space and headroom inside the car

### Package includes:

- 5 Point harness
- Recline function
- Tilt angle adjustment (0 to 20°)
- ISOFIX attachment
- Standard head support
- Fixed lateral supports
- Slim swivel base - left turn only
- Seat belt guide on the left



Size	Code	Max Weight	Seat Width	Seat Depth	Shoulder Height	Lateral Height	Lateral Width	Weight
2	4170-0021-060	36kg	31-35cm	34-39cm	48-55cm	25-29cm	23-32cm	8.9kg
3	4170-0031-090	75kg	36-40cm	40-46cm	55-64cm	30-36cm	29-40cm	12.3kg

## ACCESSORIES

### Support Tray Table

2: 4170-5532-000  
3: 4170-5533-000

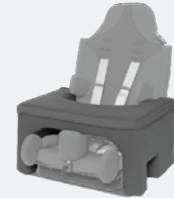

### Foot Support

2/3: 4170-5242-000



## FUNCTIONAL BENEFITS



Easily adjustable in seat depth.



Angle adjustable back support



Ample growth opportunities.



# Vehicle Harnesses



Travelling safely in the car is important for everyone. Our harnesses can provide additional postural support to keep a person upright in their vehicle seat. There are also different safety options available to ensure the person remains sitting in their vehicle seat during transportation.

Our harnesses are a support only – it is the vehicle seat belt that is the method of restraint in the event of a motor vehicle accident. This means the vehicle seat belt must always be used with the harness.

---

Vehicle Harnesses	
Medifab Harnesses	60
Houdini Harnesses	64
Walking Rein	66

---

# Medifab Vehicle Harnesses

Medifab has had many years of experience with providing solutions for passengers who require support during travel. Some passengers with disabilities may require additional support to keep them upright and safe, whilst others with behaviours of concern may require a type of support that will allow them to remain within the vehicle seat, reducing the risk of danger to themselves and other passengers.

Houdini Harness Checklist	
Question	Product Suggestion
Does your client require a vehicle harness to assist with remaining in the vehicle seat due to behaviour of concern?	All models appropriate. Use the shoulder cross strap to prevent the straps slipping off the shoulders if necessary.
Does your client require a vehicle harness for physical disability? (To provide additional posture support).	Model 27 or 28 Ask us for standard press-release buckles if necessary.
Level of client fine motor skill or coordination: (for clients requiring escape proof buckles) <ul style="list-style-type: none"> <li>• Reasonable</li> <li>• Limited</li> <li>• No fine motor skills</li> </ul>	<ul style="list-style-type: none"> <li>• Reasonable – Ask us regarding an upgrade to a pen/key release system.</li> <li>• Limited – Use the Metal Anti-Escape buckle (comes standard on Models 27, 28 and 31). We also recommend the shoulder cross strap used in conjunction with the harness of choice.</li> <li>• No fine motor skills – Consider standard press release buckle option</li> </ul>
Is the harness going to be installed on a: <ul style="list-style-type: none"> <li>• Single seat (e.g. front seat or 1 person back support)</li> <li>• Bench seat</li> <li>• Deep contoured single seat</li> </ul>	<ul style="list-style-type: none"> <li>• Single seat – Models 13, 22, 27, 28, or 31.</li> <li>• Bench seat – Models 22, 28, or 31.</li> <li>• Deep contoured single seat – Model 22 or 28.</li> </ul>
What vehicle is the harness going to be installed in: <ul style="list-style-type: none"> <li>• Taxi (e.g. for school travel)</li> <li>• Using in multiple vehicles</li> <li>• One vehicle only</li> </ul>	<ul style="list-style-type: none"> <li>• Taxi – Models 22, 28, or 31.</li> <li>• Using in multiple vehicles – Model 22</li> <li>• One vehicle only – Any harness from the range.</li> </ul>

# Frequently Asked Questions

---

## **Do I require a tether point attachment?**

No. The harnesses are simply strapped to the existing vehicle seat.

## **Can I use the harness on an aeroplane?**

Yes, however you must get written permission from the airline prior to departure.

## **What do I do if there is no access behind the seat for the attaching straps, i.e. in the back seat of a sedan vehicle?**

Cut some small slots in the rear carpet flap so the attaching straps can be threaded through (the parcel shelf may have to be removed).

## **Can I use the harness with a booster or car seat?**

No. The harnesses are intended to be used by people over the age of 7 who are large enough to travel sitting on the vehicle seat with an adult seat belt. To check if the client is large enough for this, they need to meet all parts of the 5 Step Test to ensure good seat belt fitment.

Australian road law states children aged between 4 and 7 must travel in an approved booster seat. A child should be at least 145cm tall and pass the 5-step test before transitioning to the vehicle seat. Medifab's vehicle harness options should not be used in combination with a car seat or booster seat unless as an option of last resort (with appropriate risk assessment). If person does not pass all 5 checks in the 5 Step Test, consider car/booster seat options as an alternative solution.

To learn more about the 5 Step Test, refer to:  
<https://childroadsafety.org.au/cars/five-step-test/>

Or scan the QR code below:



*These are not safety harnesses and must be worn in conjunction with the vehicle safety belt.*

# Vehicle Harness Comparison Chart

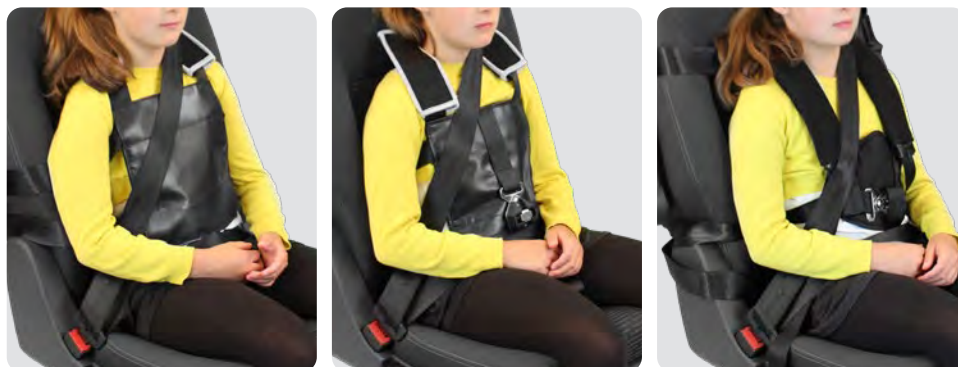

SPECIFICATIONS	HOUDINI 13		HOUDINI 22		HOUDINI 27	
	13J	13H	22C	22D	27A	27B
DESCRIPTION	All buckles are behind the seat so user cannot release them.		Popular option for taxis. Body section attaches to user before entering the vehicle. Multiple seat straps can be purchased.		Full 5 point harness for more postural control. For single back support seat only.	
APPROX AGE OF USER*	3-8yrs	7-Adult	3-8yrs	7-Adult	3-8yrs	7-Adult
GAP REQUIRED BETWEEN SEAT & BACK SUPPORT?	✓	✓	✓	✓	✗	✗
CAN BE FITTED TO USER BEFORE ENTERING THE VEHICLE	✗	✗	3 2 piece harness. 2nd piece stays in vehicle		✗	✗
SINGLE SEAT COMPATIBLE	✓ (Not suitable with built in headrest)		✓		✓	
BENCH SEAT COMPATIBLE	✗		✓		✗	
COMMENTS	To fit the harness easy access is required all the way round the seat back and underneath the base of the seat cushion.		The body harness is worn before entering the vehicle. It is fitted with a waist belt and chest strap which fasten behind the passenger's back with side-release buckles.		Can offer postural support and assist in seating the occupant in an upright sitting position for those with physical disabilities where extra support and positioning is required during travel.	
BUCKLE TYPE**	Std.../AE/PP		AE/PP/MAG.		AE/Std.../PP	
RESTRAINT LEVEL	Mild		Moderate/High		Moderate	
FIXING TYPE	Buckles connect around rear of seat.		Vertical fixing straps installs to vehicle seat first.		2 horizontal straps connect to vehicle seat.	

\*Indicator only. Australian road law states children aged between 4 and 7 must travel in an approved booster seat. A child should be at least 145cm tall and pass the 5-Step Test before transitioning to the vehicle seat. Medifab's vehicle harness options should not be used in combination with a car seat or booster seat unless as an option of last resort. If person does not pass all 5 checks in the 5 Step Test, consider car/booster seat options as an alternative solution.

\*\* AE = Anti-escape PP= Pen/Key Release Std.= Push Button Mag.= Magnetic Upgrade

Medifab is as diligent as possible in compiling this information. Medifab does not guarantee the correctness and completeness of the information provided. Equally, Medifab does not guarantee that this information is up to date. For questions concerning our products, their specifications and their utilisation please refer to the instruction manual and/or a product consultant of Medifab. Product specifications are subject to change without notice.



HOUDINI 28	HOUDINI 31	
28	31A	31B
Same as Model 27, however this popular version is designed for bench vehicle seats.	Most secure harness. 7 point control with bib front to secure the torso effectively.	
7-Adult	3-8yrs	7-Adult
✓	✓	✓
✗	✗	✗
✓	✓	
✓	✓	
Very popular harness. This Houdini 28 harness is similar to the Houdini 27 except that the seat attachment straps go vertically around the vehicle seat.	Offers greater support due to a front PVC pad that is attached around the individual's torso with two straps fitted with anti-escape buckles.	
AE/Std.../PP	AE/PP/MAG.	
Moderate	High	
2 vertical straps connect to vehicle seat.	2 horizontal straps connect to vehicle seat.	

# Houdini 13 Harness

- Can be fitted on **wheelchairs and some easy chairs** as well as using in vehicles
- All buckles are **behind the seat** so the user cannot release them

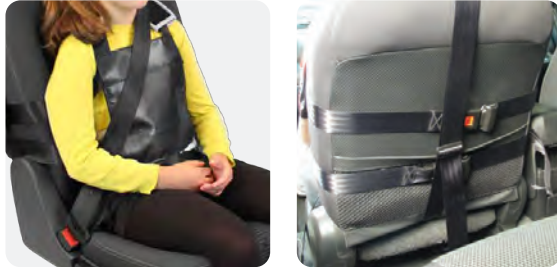

Model	Standard Push Press Buckle	Pen-Key Release Buckle	Age Group
13J	4604-1302-017	4604-1302-031	3 to 8 years
13H	4604-1303-017	4604-1303-031	7yrs to Adult

## MODEL 13 BENEFITS

Suitable for use with people who are confused or demonstrate behaviours of concern, as all the buckles are behind the seat back.

In vehicles, this harness is suitable for use on a **single seat only**, and requires a gap between the vehicle seat and back support for installation.

Not a safety harness: must be worn in conjunction with vehicle safety belt.

# Houdini 22 Harness

TAXI

- Can be used on **single or bench seats**
- Fit to the user **before entering vehicle**
- Good option for **taxi's** and also suitable for hip spicas

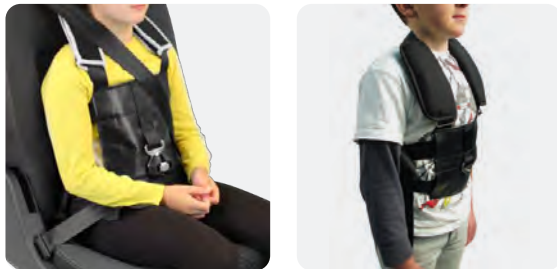

Model	Anti-Escape Buckle	Pen-Key Release Buckle	Age Group
22C	4604-2211-017	4604-2211-031	3 to 8 years
22D	4604-2212-017	4604-2212-031	7yrs to Adult

## MODEL 22 BENEFITS

Consists of a removable torso section which is attached to the individual prior to entering the vehicle.

Once the individual is seated, two buckles are engaged to provide safe travel.

Not a safety harness: must be worn in conjunction with vehicle safety belt.



**Additional seat attachment strap for use in another vehicle:**  
4604-2222-017

# Houdini 27 Harness



- **Centre-release buckle** to provide postural support, **anti-escape** to prevent removal
- Attachment straps **fasten horizontally** around seat
- Suitable for single back support seats and **air travel\***



Model	Centre-Release Buckle	Anti-Escape Buckle	Pen-Key Release Buckle	Age Group
27A	4604-2702-017	4604-2702-026	4604-2702-031	3 to 8yrs
27B	4604-2703-017	4604-2703-026	4604-2703-031	7yrs to Adult

## MODEL 27 BENEFITS

Designed to offer postural support and a certain degree of restraint as it is a full 5-point harness. Identical to Houdini 28; however straps fasten horizontally (28's fasten vertically).

Only suitable for single-backed seats.

Not a safety harness: must be worn in conjunction with vehicle safety belt.

\* Signed approval must be obtained from the airline prior to travel.



# Houdini 28 Harness

- Medifab's **most popular** model of Houdini Harness
- Attachment straps **fasten vertically** around seat
- **Centre-release buckle to provide** postural support, **anti-escape** to prevent removal



Model	Anti-Escape Buckle	Centre-Release Buckle	Pen-Key Release Buckle	Age Group
28	-	4604-2803-017	4604-2803-031	Junior to Adult
28SB	4604-2803-026	-	-	Junior to Adult

## MODEL 28 BENEFITS

Designed to offer postural support and a certain degree of restraint as it is a full 5-point harness. This harness is the same as the Model 27, however the seat attachment straps go vertically around the vehicle seat.

This is suitable for **single or bench seats**. For seats that 'narrow' towards the top of the back support, the Model 27 is more suitable. Not a safety harness: must be worn in conjunction with vehicle safety belt.

# Houdini 31 Harness

- **Most secure harness**, with twin anti-escape buckles
- Can be used on **deep 'bucket' single or bench seat**

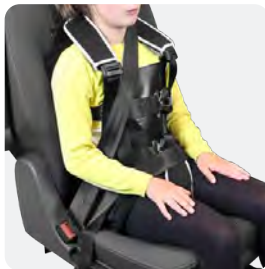

Model	Anti-Escape Buckle	Pen-Key Release Buckle	Age Group
31A	4604-3101-017	4604-3101-031	3 to 8yrs
31B	4604-3102-017	4604-3102-031	7yrs to Adult

## MODEL 31 BENEFITS

This harness offers more support due to a front PVC pad that is attached around the individual's torso with two straps fitted with anti-escape buckles.

Not a safety harness: must be worn in conjunction with vehicle safety belt.

## CROSS STRAP

Fit to a harness to hold shoulder straps together & prevent them slipping off.

**PVC with side-release buckle**  
4604-3112-019

**PVC with anti-escape**  
4604-3004-026

**PVC with pen release**  
4604-3004-025



**Cross Strap Padded Sleeve (side release buckle)**  
Sml 4604-3117-017  
Lge 4604-3118-017



Designs and styles may vary.

## BUCKLE OPTIONS:



### Anti-Escape

Successfully prevents those with inquisitive fingers, challenging behaviour or learning difficulties from releasing the buckle. Operates in reverse to normal, as it is disengaged by raising a spring-loaded lever and will not press release.



### Pen/Key Release

Requires a tool such as a pointed pen or key to prod the buckle release mechanism to open. Medifab supply a release tool with each of these buckles.

# Walking Rein

Curious individuals with behaviours of concern can suddenly slip out of your sight despite your best intentions. A walking rein will help you keep your loved ones close.

Help keep children and adults safe when out walking



**Parent/carer's rein** is attached to the side straps which can act as a directional aid, helping to guide the user

May prevent personal harm by offering a certain **degree of restraint**

Chest pad is made from fire-retardant PVC and is easy to **wipe clean**

Particularly good for those with a limited sense of **safety awareness**



Ideal to use as a back-up safety method to keep someone within reach, especially during walks to the park where the dangerous roads are never far or in shopping centres where lots of people are distracting.

It is important for safety reasons that the rein strap is always held behind the child and not pulled from the front. This ensures the strain is on the very strong webbing belts and not on the PVC chest pad.

\*Note: Never leave your child unattended. This product is not a substitute for proper adult supervision

Model	Code	Age/Size
Standard	4605-0062-017	Fits most ages, up to 97cm waist circumference
Small Escapologist	4605-0065-017	Up to 8yrs
Large Escapologist	4605-0066-017	9yrs to adult

## VERSIONS AVAILABLE

### Standard rein

Waist belt plus chest strap and detachable rein strap



### Escapologist Rein

For the very active person. Fitted with a chest belt, waist belt and shoulder straps. Has adjustable and detachable rein.









## Standing Aids



Our standing support solutions cater to various support needs and sizes, spanning from early intervention to older teens and adults.

---

Jenx Monkey Stander	72
Jenx Multistander	73
Jenx Multistander with Abduction	74
Jenx Standz Size 1	75
Jenx Standz Size 2	76
Jenx Supine Stander	78

---

# Standing Frame Comparison Chart



SPECIFICATIONS	JENX MONKEY	JENX MULTISTANDER		
		SIZE 1	SIZE 1 (ABDUCTION)	SIZE 2
USAGE	Prone	Supine/Prone		
APPROX AGE	9mths-4yrs	9mths-6yrs	9mths-6yrs	3yrs-13yrs
MAX WEIGHT (kg)	25	35	35	60
MAX HEIGHT OF HEAD SUPPORT (cm)	N/A	116	116	155
FOOTPLATE TO TOP OF CHEST SUPPORT (cm)	51-75	49-85	50-89	75-120
CHEST SUPPORT WIDTH (cm)	18.5-28.5	14-27.5	14-27.5	20-32
HIP SUPPORT WIDTH (cm)	18.5-28.5	14-27.5	14-27.5	20-32
TILT RANGE (90° AS UPRIGHT)	20-90	10-90	10-90	0-85 (Electric) 10-85 (Gas)
TILT OPERATION	Gas	Gas		Gas or Electric
POSTURAL SUPPORT LEVEL	Mild/Mod	Mild-Complex		
FRAME FOOTPRINT (cm)	58 x 88.5	61.5 x 76	61.5 x 76	67.5 x 107
ABDUCTION	✗	✗	30° each leg	✗
KNEE FLEXION CONTRACTURE ACCOMMODATION	✗	Supine: ✓ Prone: ✗		



JENX STANDZ		JENX SUPINE		
SIZE 1	SIZE 2	SIZE 1	SIZE 2	SIZE 3
Supine/Prone		Supine		
1-9yrs	5-14yrs	9mths-4yrs	3-11yrs	10-Adult
45	70	25	50	100
138	160	106	146	190
58-100	82 - 116	The chest supports can be fitted at any available slot on the supine stander.		
17.5-30.5	22-36	13-31	13-31	22-44
17.5-30.5	25-37	13-31	13-31	22-44
5-90	0-90	10-90	10-90	5-90
Gas		Gas	Electric	
Mild-Complex		Mild-Complex		
64.5 x 89	76 x 107	57.5 x 66	65 x 99	75 x 107
30° each leg		✗		
Supine: ✓ Prone: ✗			✓	

Medifab is as diligent as possible in compiling this information. Medifab does not guarantee the correctness and completeness of the information provided. Equally, Medifab does not guarantee that this information is up to date. For questions concerning our products, their specifications and their utilisation please refer to the instruction manual and/or a product consultant of Medifab. Product specifications are subject to change without notice.

# Jenx Monkey Stander

Specifically designed for younger children, the Jenx Monkey is a gentle and fun introduction to standing, providing prone to upright positioning.

## Simple and highly adjustable prone/upright standing frame



**De-rotational thoracic & pelvic straps** with lateral trunk support pads that fasten in the centre and adjust independently from either side, enabling a mid-line position to be achieved and maintained

Polyurethane support surfaces **with antimicrobial agent**

**Integral angle-adjustable tray** with both bowl and smooth tray infill for a wide variety of activities

**Quick, simple & easy to use.** Comes standard with thumb screw adjustment of growth and postural supports, no tools required!



**Gentle, bright & friendly**

For parents, a new diagnosis for their young child can be a difficult time, especially when introduced to the world of postural care equipment and the associated vocabulary. The Monkey has been carefully designed to offer the best in early intervention support in a friendly way.



Flexible growth: chest and hip boards can be independently adjusted to support the child as they grow.

Fully upholstered chest, hip and leg boards help make standing more comfortable, to increase standing tolerance.

Angle can be adjusted with the child in the frame and set to the correct angle with infinite adjustment.

## ACCESSORIES

### Tray Grab Bar

When 1 hand needs to fix to increase functionality  
5050-7201-000



### Activity Frame

Encourages head control & hand/eye coordination  
3615-7475-000



### Sandal Raising Blocks

Size 1: 5356-6091-000



## CASE STUDY: CHILD A

**Condition:** Hydrocephalus, prematurity resulting in prolonged hospital stay from birth.

**Background:** Child A was born prematurely with complex needs resulting in a prolonged 18 month stay in hospital. Once home Child A was on home O<sup>2</sup>, PEG fed and presenting developmental delay. He has moderate head control, some trunk activity, but no independent sitting balance.

**General and Emotional benefits (from trialling the Jenx Monkey):** Child A is able to practice weight bearing and ensure better hip development and bone density. Plus the change of position gives Child A greater access to the world and interaction on that level. As Child A is very small even though nearly 2 years old, sandal raising blocks were needed to ensure the appropriate level of support and a good stand are achieved.

The stander has also meant reduced physical support required to be provided by Mum, allowing her to play with Child A on better level, making both mum and Child A much happier.

Code	Age	Max User Weight	Angle Range	Base Size	Chest Height (Foot Support-Chest pad top)	Chest Pad Width	Hip Pad Width	Tray Size
5050-0001-000	9mths-4yrs	25kg	20°-90°	88 x 57.5cm	51-75cm	66 x 50 x 60cm	15-23.5cm	36 d x 53 wcm



# Jenx Multistander

Versatile standing frame, suitable for children from around 9 months right up to 13 years across 2 sizes which provides highly supportive standing. Ideal for growing children in multi-use environments.

## Supine, Prone & Upright Standing Frame

**De-rotational thoracic & pelvic straps** fasten in the centre and adjust independently from either side, enabling a mid-line position to be achieved and maintained. Pads easily remove for side transfers in Supine



**Independently adjustable thoracic and pelvic boards** cater for the child's individual proportions while giving scope to avoid pressure on delicate areas such as feeding buttons

**PU boards and support pads** are flexible, easy clean and hygienic

**Deliberately open design** ensures you can always see precisely how the user is positioned each and every time



### Always supportive!

The Multistander is multi-positional meaning it has the flexibility to grow and change with the child easily, supporting them as their skills develop. Prone or Supine configurations mean the correct level of support is always achievable.



Huge growth range. Size 1 shown at smallest height; Size 2 at largest height. (Size 2 provides option for power or manual adjustment).



Angle can be adjusted with the child in the frame and is easily set using the angle gauge.



Set to exactly the right angle with continuous adjustment. Horizontal position assists transfers.

## ACCESSORIES



Choose from Lime -054 or Blue -066 colour ways in most accessories

### Multigrip Head Support

1 Link: 5356-4601-000  
2 Link: 5356-4602-000  
3 Link: 5356-4603-000



### Moulded Head Support

5230-4101-XXX

### Oval Head Support

5356-4611-XXX



### Lateral Trunk Supports

Slim Thoracic: 5356-3241-XXX  
Hi-Rise Thoracic: 5230-3251-XXX



### Multi-Use Tray

Size 1: 5230-7111-000  
Size 2: 5230-7112-000  
Elbow Blocks: 5356-7351

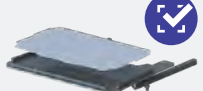

### Multigrip Body Support Size 2:

5230-2721-XXX



### Hip Supports

5356-3221-XXX



### Sternal Prompt (Prone)

5230-2910-000  
Cover: 5230-8801



### Knee Supports

Size 1: 5356-1751-XXX  
Size 2: 5356-1752-XXX



### Waistcoat Anterior Chest Support

Size 2: 5230-6712-000  
Size 3: 5230-6713-000  
Size 4: 5230-6714-000



### Sandals

Size 1: 5356-6081-000  
Size 2: 5356-6082-000  
Size 3: 5356-6083-000



Size	Code	Age	Max User Height	Angle Range	Frame Width	Chest Pad Width	Hip Pad Width	Chest Pad Height	Height of Stander	Foot Support
1	5230-0001	9mths-6yrs	116cm	10° - 90°	50-90cm	9cm	66 x 50 x 60cm	Prone 49-86cm Supine 57-86cm	67-94cm	-15°
2	5230-0002	3-13yrs	175cm	0° - 80°	67-113cm	10cm	86 x 80 x 74cm	Prone 70-117cm Supine 77-117cm	83-128cm	+15°

# Jenx Multistander with Abduction

The abduction accessory for the Multistander size 1 offers children the opportunity to stand in abduction.

## Abduction standing for children as young as 9 months



**0-30° hip abduction** can be achieved in each leg in 5° incremental stages

Simple, **tool free adjustment** using a strong locking mechanism to keep the hip position secure

**Abducted standing** close to the floor, facilitating play and interaction with peers at eye level

Offers **smaller children** (as young as 9 months) the opportunity to continue standing at peer height in either a neutral or abducted hip position



### Retrofit to your Multistander

The Multistander Abduction accessory is available for purchase as a standalone accessory to retrofit to your existing Multistander Size 1.

### ACCESSORIES

All Jenx Multistander accessories seen on the previous page, are compatible with the Jenx Multistander Abduction accessory.



**Mounting bracket for Harness**  
(Required for Size 1 Multistander with Abduction only).  
5230-part-056



Code	Angle Range	Age Range	Max User Height	Frame Width	Frame Length	Chest & Hip Pad Width	Knee Block Width
5230-5000-000	0-90°	9mths - 6yrs	116cm	56.5cm	71cm	14 - 27.5cm	12-40cm
Height of Stander	Leg Abduction	Max User Weight	Foot Support Angle Dorsiflexion	Foot Support Angle Plantarflexion			
61-94cm	30°	35kg	15°	15°			

This includes the Abduction Accessory only without the Multistander frame.

# Jenx Standz Size 1

Standz offers abducted hip positioning for children between the ages of 1-9. It can be used with or without abduction, depending on individual needs and goals.

## Supine/Prone/Upright/Abduction Standing Frame

**Built in angle gauges** for frame angle and individual leg abduction



**Tool free adjustments** - cleverly designed wing knobs offer a comfortable grip to enable effective clamping with minimal effort

**Standz covers have been designed to wipe clean**, they also contain an antimicrobial agent to aid infection control

**Adjustable supports** to accommodate knee flexion contractures and leg length discrepancies



### Standard configuration

- Base with castors
- Hydraulic assisted tilt
- Pelvic and trunk support pads with strap
- Abducting legs
- Foot positioning plates
- Tray mount

The Standz is able to be used in the Prone or Supine configuration, depending on your child's needs



## ACCESSORIES

**Flat Pad Head Support**  
5240-4110-044



**Multigrip Head Support**  
1 Link: 5356-4601-000  
2 Link: 5356-4602-000  
3 Link: 5356-4603-000



**Flat Shoulder Support**  
5240-2750-044



**Multigrip Body Support**  
5240-2721-044



**Pelvic Support Board**  
5240-1901-044



**Back Pad**  
5240-2402-044



**Standard Knee Support**  
5240-1750-044



**Multi-Axis Knee Support**  
5240-1770-044



**Tray**  
5240-7112-044



**Knee Block**  
Size 1 5356-1751-000  
Size 2 5242-1767-054



**Sandals**  
Size 1 5356-6081-000  
Size 2 5356-6082-000



**Knee Block Mounting Bracket**  
5240-1720-000



Code	Angle Range	Age Range	Max User Height	Frame Width	Frame Length	Chest & Hip Pad Width
5240-0005-044	0-90°	1-9yrs	138cm	63.5cm	90cm	18-30cm
Knee Block Width	Height of Stander	Leg Abduction	Max User Weight	Foot Support Angle Dorsiflexion	Foot Support Angle Plantarflexion	
12cm	108cm	30°	45kg	10°	-25°	

# Jenx Standz Size 2

Standz 2 offers prone or supine standing and easily accommodates either abducted or neutral leg positioning for children between the ages of 5-14.

## Supine/Prone/Upright/Abduction Standing Frame

Abduction settings are adjusted through a **cleverly designed plunger system**, locking the setting at the desired level and preventing movement



**Tool free adjustments** - cleverly designed wing knobs offer a comfortable grip to enable effective clamping with minimal effort

**Can be configured to be tool adjustable only**, limiting unwanted movement of supports.

Covers have been designed to **wipe clean**, they also contain an antimicrobial agent to aid infection control

**Adjustable supports** to accommodate knee flexion contractures and leg length discrepancies



### Base Frame Features

- 4 lockable swivel castors
- Tilt mechanism with dedicated release lever on handle with safety lock
- 0°-30° independent abduction movement of leg posts in 5 degree increments with easy to use locking plunger
- Individual footplates with angle adjustment for plantar and dorsiflexion
- Tilt range of 5°-90° with easy to read angle gauge
- Pelvic and trunk support boards and cover pads

The Standz 2 is able to be used in the prone or supine configuration, depending on your child's needs.



## Enhanced Upper Limb Positioning

Supportive upper limb accessories ensure that the user is in the best position for function whilst standing, stabilising the shoulder and promoting midline function.



Code	Average Age	Weight Capacity	Hip Width	Hip Height	Chest Width	Chest Height	Max Height	Tilt Range (90° = Upright)	Frame Width	Frame Length	Height off surface when horizontal	Abduction Range
5242-0005-054	5-14yrs	70kg	25-37cm	50-95cm	22-36cm	82-116cm	160cm	0-90°	76cm	107cm	90cm	30°

# Accessories

**Standard Knee Support**  
5242-1750-054



**Standard Knee Straps**  
Size 1 5242-1766-054  
Size 2 5242-1767-054



**Rotation Control Knee Straps**  
Size 1 5242-1786-054  
Size 2 5242-1787-054



**Flat Shoulder Support**  
5242-2750-054

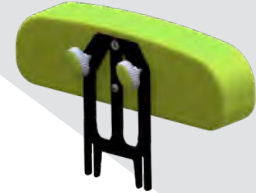

**Shoulder Support**  
Size 1 5242-2751-054  
Size 2 5242-2752-054



**Flip-Away Lateral Support with Strap**  
5242-3371-054



**Flexi Flip Away Lateral Support with Strap**  
5242-3372-054



**Ankle Snugs**  
Size 1 5356-6121-000  
Size 2 5356-6122-000



**Multi-Axis Knee Support**  
Size 1 5242-1770-054  
Size 2 5242-1771-054



**Knee Block**  
Size 1 5356-1751-000  
Size 2 5242-1767-054



**Knee Block Mounting Bracket**  
5240-1720-000



**Oval Head Support**  
5356-4611-054



**Sandals**  
Size 1 5356-6081-000  
Size 2 5356-6082-000  
Size 3 5356-6083-000



**Multigrip™ Head Support Link**  
1 Link 5356-4601-000  
2 Link 5356-4602-000  
3 Link 5356-4603-000



**Pelvic Support Board**  
5242-1903-054



**Pelvic Support Board Back Pad**  
5242-1902-054



**Waistcoat**  
Size 2 5242-6252-000  
Size 3 5242-6253-000



**Anti Tamper Conversion Kit**  
5240-0170-000

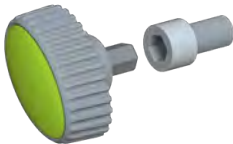

**Multi-Position Tray**  
5242-7110-054

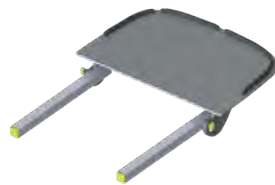

**Full Tray Padding**  
5242-7115-000



Standz 2 can be configured to be tool adjustable only, limiting unwanted movement of supports.

**Multi-Position Tray with Bowl**  
5242-7113-054

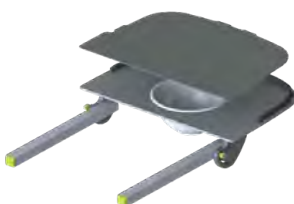

**Tray Extension Wings**  
5242-7355-000



**Tray Padded Wings**  
5242-7116-000



**Tray Elbow Blocks**  
5356-7351-000



# Jenx Supine Stander

Highly supportive supine standing offering easy transfers and support of complex postures from 9 months to adults up to 100kg.

## Robust Support and Safety

Size 3 has exclusive **numbered boards** so that set-ups can easily be recorded and recreated in a multi-user environment



**PU boards and support pads** are flexible, easy to clean and hygienic

**De-rotational thoracic & pelvic straps** fasten in the centre and adjust independently from either side, enabling a mid-line position to be achieved and maintained

**De-rotational and flexion control** accessories available to customise knee support for each individual

**Split angle adjustable** foot support for Size 3 and Single footboard for Size 1/2



### Supporting development

The adjustable supports of the Jenx Supine Stander mean that support can be tailored to each individual based on their level of function. To support development, freedom of movement at different joints can be gradually introduced to assist with training of balance and motor control.



Easy set up using the frame's angle gauge. Angle can be adjusted with user in the frame.



Infinite and precise angle adjustment from upright 90° through to horizontal.



Smooth and easy transfers with ability to remove support pads fully. Less carer strain!

### ACCESSORIES



**Multigrip Headrest**  
 1 Link: 5350-4601-000  
 2 Link: 5350-4602-000  
 3 Link: 5350-4603-000

Choose from Lime -054 or Blue -066 colour ways

**Head Pad Cushion**  
 Size 3: 5353-4602-066  
 1/2 & wings: 5350-4650-XXX  
 3 & wings: 5350-4103-XXX





**Support Pads & Straps**  
 Small: 5356-3222-XXX  
 Medium: 5356-3241-XXX  
 Large: 5353-3223-XXX  
 X-Large: 5353-3224-XXX



**Knee Blocks & Straps**  
 Small: 5350-1761-XXX  
 Medium: 5350-1762-XXX  
 XL 1: 5353-1765-XXX  
 XL 2: 5353-1766-XXX  
 XL 3: 5353-1767-XXX



**Flexion Control Knee Support**  
 Medium: 5350-1772-XXX  
 XL 1: 5353-1775-XXX  
 XL 2: 5353-1776-XXX  
 XL 3: 5353-1777-XXX



**Adjustable Tray**  
 Size 1/2: 5350-7111-000  
 Size 3: 5353-7113-000  
 Elbow blocks: 5356-7351  
 Tray Extension Wings: 5353-7170-000



**Medial Knee Support (for Size 3)**  
 5353-1603-066  
**Arched Foam Pad Support** behind flexed knees:  
 5353-1775-000  
**Spacer:**  
 5353-2730-000



**Sandals**  
 Size 1: 5356-6081-000  
 Size 2: 5356-6082-000  
 Size 3: 5356-6083-000  
 Size 4: 5356-6084-000

Size	Code	Age	Max User Weight	Max User Height	Base Size	Tilt	Chest Width	Hip Width	Knee Pad Width	Board Height to Foot Support
1	5350-0001-XXX	9mths-4yrs	25kg	105.5cm	57.5x66cm	0-80°	13-31cm	13-31cm	13-31cm	50-1-07cm
2	5350-0002-XXX	3-11yrs	50kg	145.5cm	65x99.5cm	0-80°	13-31cm	13-31cm	13-31cm	90-147cm
3	5353-0003-066	10-18yrs	100kg	190cm	76x99.5cm	0-80°	22-44cm	22-44cm	22-44cm	154-164cm



Standing Aids



Providing creative  
solutions for  
everyday tasks





## Bathroom



Showering and bathing are both essential activities however they can be the most challenging. Finding the correct bathroom aid that provides the right level of support can make these tasks easier and simpler.

# Sharky Bathroom Chair

Sharky has been designed for multifunctional applications and ease of handling.

Multifunctional commode for shower, bath and toilet use.

**Removable rear seat section** to assist with hygiene care

**Upgrade from size 1 to size 2** using the same slim design frame, providing a long-term solution for bathroom related needs



**3 tasks in 1**  
Removable seat that can be used with the toilet and bath adapters offers versatile support in different bathroom tasks

**Slim frame design,** great for narrow bathroom access

**Easy to clean** all surfaces



Sharky Size 1



Sharky Size 2

Seat Angle	Back Support Angle	Knee Angle	Foot Support Angle
-10° to 45°	72-120°	78-138°	80-100°

Size	Back Support Height			Seat Width	Seat Depth	Toilet Clearance	Armrest Height	Wheel Diameter	Weight Limit
	35cm	45cm	55cm						
1	6081-0010-100	6081-0010-000	N/A	24, 27, 30cm	27-36cm	52cm	14.5 - 20.5cm	75mm	60kg
2	N/A	6082-0015-100	6082-0015-000	29, 32, 35cm	31-40cm	52cm	14.5 - 20.5cm		

## SHORT BACK SUPPORT SIZES

Now available with option of short back support for smaller children!



## BACK SUPPORT RECLINE

Simple to use system for easy and secure handling.



## 45° TILT

The special construction of the tilt mechanism allows for 45° tilt of seat to ensure comfort and safety especially when showering.



## HEIGHT ADJUSTMENT

Smooth movement with comfortable handles make adjustments easy and controlled.



## COMPACT FOLDING

Fold down to compact height of just 28cm, even with seat attached, makes transport and storage easy.



# Accessories

**Removable  
Footrest System**  
Size 1: 6085-1810-000  
Size 2: 6085-1820-000



**Push Handles**  
6085-8600-000



**Lateral Trunk Supports**  
Size 1: 6085-3310-000  
Size 2: 6085-3320-000

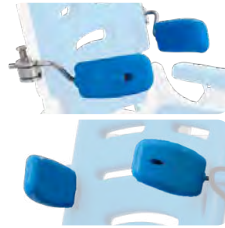

**Headrest**  
6085-4750-000



**Neoprene Shoulder  
Anterior Chest Support**  
Size 1: 6085-6610-000  
Size 2: 6085-6620-000



**Hip Belt with  
Neoprene Pad Sizes**  
Size 1: 6085-1910-000  
Size 2: 2880-1920-000



**Removable & Height  
Adjustable Arm Supports**  
6085-5500-000



**Abduction Block**  
Size 1: 6085-1500-000  
Size 2: 6085-1520-000



**Depth Adjustable,  
removable tray table**  
Size 1: 6085-7100-000  
Size 2: 6085-7200-000



*Note: Arm  
Supports  
required*

**Neoprene Calf Strap**  
Size 1: 6085-6160-000  
Size 2: 6085-6260-000



**Neoprene Ankle Huggers**  
Size 1: 6085-6101-000  
Size 2: 6085-6102-000



**Removable Commode  
Pan with retainer**  
6085-8210-000



**Removable Splash Guard**  
6085-7675-000



**Seat Infill pad**  
6085-0401-000



**Bath subframe with seat  
angle adjustment**  
Size 1: 6085-0500-000  
Size 2: 6085-0520-000

*Note: Minimum width  
of bath 36cm*



**Toilet Adapter**  
Size 1: 6085-0600-000  
Size 2: 6085-0620-000



**Seat width reducing hip  
supports - Size 1 Sharky**  
24cm: 6085-1110-000  
27cm: 6085-1120-000  
30cm: 6085-1130-000



**Seat width reducing hip  
supports - Size 2 Sharky**  
29cm: 6085-1210-000  
32cm: 6085-1220-000  
35cm: 6085-1230-000



**Upgrade Kit**  
Upgrade from Sharky  
Size 1 to Size 2  
6085-8081-086





## New Sleep Catalogue

July 2024 Update

Scan QR code to  
receive a copy:

(Pending release)



# Lying and Positioning



A 24-hour postural management program is essential to ensuring posture is maintained at its optimum level.

Because everyone is different and has different needs for positioning, Medifab's lying and positioning range includes basic pillows to highly customised sleeping systems.

Offering a large array of components that can be customised to suit the users needs and body shape.



---

Poz-in-Form	86
CareWave	90
Simple Stuff Works	96
Dreama	102

---

CARE CONCEPT  
**POZ' IN' FORM®**  
 PHARMAQUEST INDUSTRIES

Poz'In'Form® cushions are designed to perform various support and comfort functions to support users in lying and at night time. The microfibers prevent from creep effects that are regularly observed in classical positioning and from early deterioration of the support. The various forms, sizes and models of Poz'In'Form allow for a wide range of positioning possibilities.

- Poz'In'Form elements and modules are entirely removable and washable. They are delivered with a Pharmatex or Lenzing FR® cover.
- The Pharmatex bi-elastic cover is made of polyurethane and is recommended for use in healthcare facilities. Pharmatex is soft to the touch and very comfortable next to the skin, while still easy to clean.
- The Lenzing FR cover is made of viscose, coated with a waterproof polyurethane film. Lenzing FR is a major innovation in positioning of the long-term bedridden, preventing maceration. Hygroscopic properties of viscose allow moisture absorption which is particularly important for people with thermoregulation issues. Moreover elasticity and flexibility of Lenzing FR are particularly suitable for problems regularly observed in classical positioning
- Lenzing spare covers can be purchased to cover Pharmatex pillows for a more absorbent feel.



• Lenzing FR® Cover (Breathable, yet waterproof)



• Pharmatex Cover (Wipe-down)

## Poz'In'Form Delta

- This cushion is highly versatile, able to support users with a range of positioning needs. Under the knees, it provides support to the joint to maintain some flexion. Used in this way, the Delta also prevents users from sliding down in their beds which reduces friction and shear forces on the sacrum.
- It can be used in a semi-fowler position and helps to maintain positioning while relieving pressure in sensitive areas (sacrum, ischial tuberosities, heels) and shifting it to low-risk zones (calves, thighs and back).



	With Pharmatex Cover	With Lenzing FR® Cover
<b>Code</b>	7009-0551-269	7009-0551-279
<b>Length</b>	56cm	56cm
<b>Height</b>	28cm	28cm
<b>Depth</b>	32cm	32cm

## Poz'In'Form Universal

- Thanks to the three sizes, the universal cushion can be used in many different ways. The larger size can be useful for supporting knee flexion or moderate hip abduction when the user is in supine.
- The small cushions provide additional support to the user where needed, thus reducing the risk of abnormal postures or areas of high pressure.



	With Pharmatex Cover
<b>Code</b>	7009-1252-269
<b>Length</b>	55cm
<b>Depth</b>	40cm

	With Lenzing FR® Cover
<b>Code</b>	7009-1252-279
<b>Length</b>	55cm
<b>Depth</b>	40cm

## Poz'In'Form Cylindrical

- Placed between the legs, the cylinder supports the upper hip and knee joints to be better aligned, reducing unwanted hip adduction and other unwanted changes to posture.
- In supine the cylinder can be applied behind the calves to alleviate pressure caused by contact between the users heels and the mattress surface.

	With Pharmatex Cover	With Lenzing FR® Cover
<b>Code</b>	7009-1501-269	7009-1501-279
<b>Length</b>	75cm	75cm
<b>Diameter</b>	18cm	18cm



## Poz'In'Form Half-Moon

- Used in supine to provide support to the head, neck and upper limbs, including the shoulders.

	With Pharmatex Cover	With Lenzing FR® Cover
<b>Code</b>	7009-1851-269	7009-1851-279
<b>Length</b>	200cm	200cm
<b>Width</b>	30cm	30cm



## Poz'In'Form Hand Wedge

- Cushion for the hands, wrists and forearms to provide greater surface area contact and distribute pressure more evenly.
- Can be particularly useful after certain surgical procedures where improved upper limb positioning is needed.

	With Lenzing FR® Cover
<b>Code</b>	7009-5411-279
<b>Length</b>	39cm
<b>Height</b>	9cm
<b>Width</b>	22cm



## Poz'In'Form Semi-Lateral Decubitus

- Used to provide body length support in semi side lying positions, from the top of the shoulders to the feet and ankles.

	With Pharmatex Cover	With Lenzing FR® Cover
<b>Code</b>	7009-3001-269	7009-3001-279
<b>Length</b>	185cm	185cm
<b>Width</b>	35cm	35cm



## Poz'In'Form Ring & Half Ring

- In combination with the cylindrical cushion the half ring can provide medial thigh and knee support, preventing hip adduction and supporting a neutral position.
- Used for positioning the neck and head, providing a comprehensively supported position when used in combination with other cushions.

	With Pharmatex Cover	With Lenzing FR® Cover
<b>Half Ring Code</b>	7009-4051-269	7009-4051-279
<b>Ring Code</b>	7009-4081-269	7009-4081-279
<b>Length</b>	105cm	135cm
<b>Width</b>	22cm	20cm



## Poz'In'Form Occiput

- Used to provide positioning and pressure relief to the occipital area in supine. Combination layers of microfibre and memory foam provide optimised pressure distribution.

	With Pharmatex Cover	With Lenzing FR® Cover
<b>Code</b>	7009-4751-269	7009-4751-279
<b>Length</b>	50cm	50cm
<b>Height</b>	9cm	9cm
<b>Width</b>	40cm	40cm

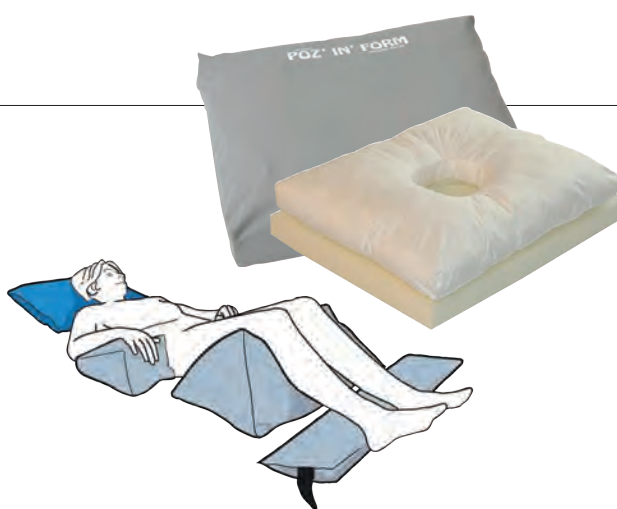



## Poz'In'Form Heel Cushion

- Used at the bottom of the bed and fixed with an adjustable strap.
- Provide support behind the calves to raise the feet away from the mattress surface, thus reducing contact and associated areas of high pressure particularly at the heels.

	With Lenzing FR® Cover
Code	7009-5201-279
Length	85cm
Diameter	25cm

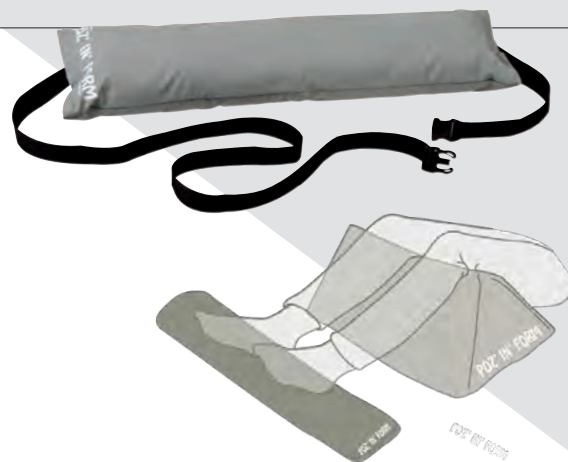

## Poz'In'Form Heel Wedge

- Alternative cushion shape for supporting the calve and relieving pressure from the heel area.
- The large surface area of the cushion provides additional support for larger calve sizes or where more contact is needed to support the user.

	With Lenzing FR® Cover
Code	7009-5401-279
Length	48cm
Height	12cm
Width	30cm



# CareWave Details

- Body positioning system which offers lying and seating support to infants and adults.
- Various cushion shapes are available depending on the user's need for positioning.
- Unique micro-particle padding provides flexibility and a moulding effect, essential to support asymmetric postures, fill body gaps and for comfort around the user's body and limbs. Available in two sizes.
- Outer cover of CareWave cushions: Waterproof and breathable Polyamid bi-elastic fabric (47%) coated with polyurethane (53%) Coating with antibacterial treatment.
- Filling: 100% Polystyrene micro-particles.
- Fire standard: Passes the requirements of EN 597 - 1&2 and EN ISO 12952 - 1 to 4.

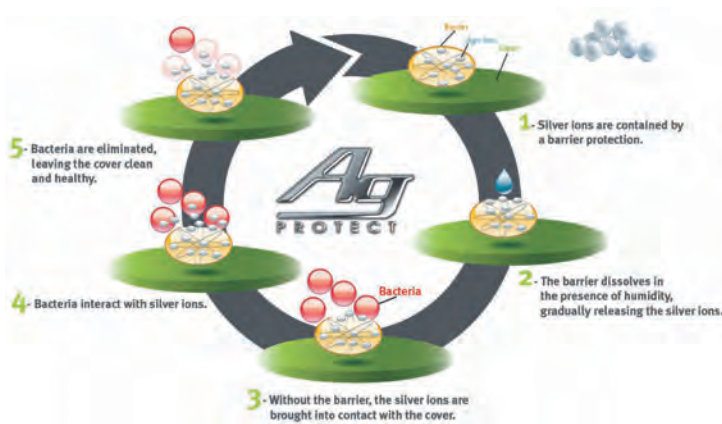

## COLOUR IDENTIFICATION

GREEN CAREWAVE = Small sizing  
 BLUE CAREWAVE = Large sizing



# Cushion Covers

- Cushion covers can be added to most sleep system items. Medifab suggest that at least one cover is purchased with each cushion. Benefits include:
  - Quick and easy to launder.
  - Breathability, allows skin to release moisture without undue discomfort or pressure marking
  - Warm to touch, adds comfort.
  - Absorbent - wicks away perspiration, saliva etc.



# Cleaning Instructions

- Cushion Maintenance:  
 Wipe with usual detergent.



## CareWave Cylindrical



- Can be used between legs, under heels and ankles in order to reduce pressure.
- Prevents the user from falling forward from a decubitus position.
- Provides sufficient support to achieve a corrected position for many users.
- Use for corrected side lying positioning for sufficient angles to keep the airway open and to ensure a neutral position in the involved joints.

	Small	Large
<b>Code</b>	7007-1502-045	7007-1501-066
<b>Length</b>	45cm	70cm
<b>Diameter</b>	14cm	17cm
<b>Cover Code</b>	7007-1502-270	7007-1501-270



## CareWave Abduction

- Use when the patient is lying down, placed in crotch area.
- Can also be placed under the arm.

	Small	Large
<b>Code</b>	7007-1552-045	7007-1551-066
<b>Width</b>	12cm	15cm
<b>Depth</b>	23cm	30cm
<b>Height</b>	15cm	20cm
<b>Cover Code</b>	7007-1552-270	7007-1551-270

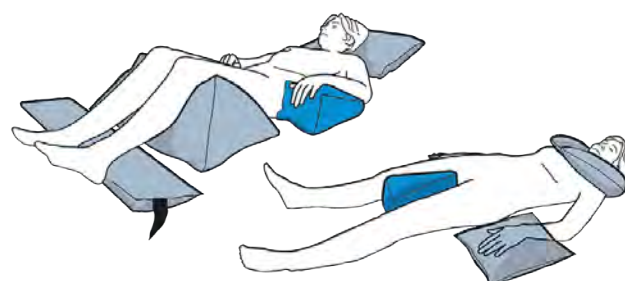

## CareWave Semi-Fowler

- Gives support and holds the user comfortably in a semi-fowler position.
- Place the cushion under the legs, the abduction module forward between the knees.

	Small	Large
<b>Code</b>	7007-1852-045	7007-1851-066
<b>Width</b>	50cm	70cm
<b>Depth</b>	35cm	50cm
<b>Height</b>	12cm	14cm
<b>Cover Code</b>	7007-1852-270	7007-1851-270



## CareWave Decubitus

- Supports shoulders, back, hips and knees of the user in a decubitus position. Reduces rubbing.
- Provides excellent trunk stability while the hip and knee angle can be varied.
- Lower part of the “S” can be drawn up between the knees so that the right median and good body symmetry can be achieved.
- Can also be shaped into a U-shaped cushion by adjusting the fill and rotating one end to thus provide a neutral position for the knee and hip joints, while the pad is pushed under the seat to fix the pelvis.
- The ends also provide support for the elbows.

	Small	Large	XX Large
<b>Code</b>	7007-3002-045	7007-3001-066	7007-3004-066
<b>Width</b>	25cm	30cm	36cm
<b>Length</b>	140cm	180cm	200cm
<b>Cover Code</b>	7007-3002-270	7007-3001-270	7007-3004-270



## CareWave Body Bolster

- New addition to the CareWave range, which allows full support of the body from head to feet.
- An integrated pillow facilitates installation and user comfort and successfully maintains user position.
- When used in lateral position, the Body Bolster protects against pressures and avoids friction and pressure points on arms, knees and calves.

	Small	Large
<b>Code</b>	7007-3502-045	7007-3501-066
<b>Length</b>	135cm	210cm
<b>Width</b>	20cm	35cm
<b>Cover Code</b>	7007-3502-270	7007-3501-270



## CareWave Back Cushion

- Maintains the back in a semi-sitting position when user is sitting in bed or in a lateral decubitus position. Helps reduce pressure on ischium and heels.
- Can also be used in a sitting position in a chair.

	Large
<b>Code</b>	7007-2451-066
<b>Length</b>	200cm
<b>Width</b>	60cm
<b>Cover Code</b>	7007-2451-270

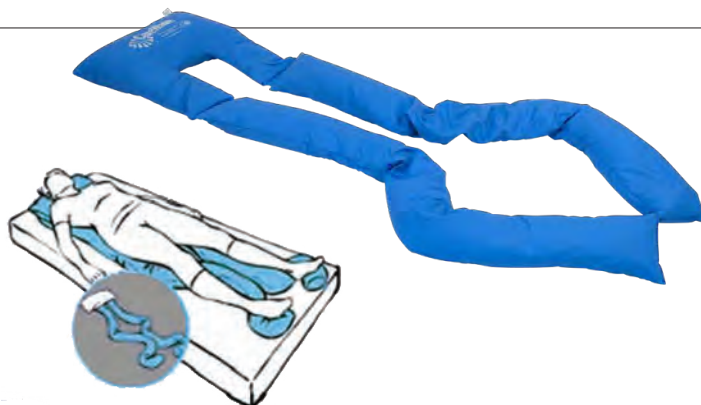

## CareWave Half-Moon

- It gives support and holds the patient comfortably in a lying or sitting position, and can be used to stabilize the upper body. The filling can be moved within the cushion so you can arrange it to adjust the head and arm height.
- If one wishes to counteract unwanted lateral movement of the body, the ends of the Half-Moon can be pushed under the hip area. Body weight will stabilize the pelvis and prevent unwanted movement. The idea is to eliminate movement that will take the body out of the desired symmetrical position.

	Small	Large
<b>Code</b>	7007-4052-045	7007-4051-066
<b>Length</b>	140cm	180cm
<b>Width</b>	25cm	30cm
<b>Cover Code</b>	7007-4052-270	7007-4051-270



## CareWave Ring Cushion

- Comfortably supports the user's head. If support is required especially on one side, the special filling can be shaken to one side of the cushion and positioned slightly skewed to one side if needed.
- Can be positioned with the opening towards the patient's visual direction which allows for a stable position for the head and neck, backwards and sideways.
- If the patient has the ability to make a lot of head movement the pillow can move out of place so the patient must be able to move the pillow or get help with this.



	Small	Large
<b>Code</b>	7007-4082-045	7007-4081-066
<b>Width</b>	35cm	40cm
<b>Cover Code</b>	7007-4082-270	7007-4081-270

## CareWave Universal

- Use to avoid rubbing between knees, calves or heels.
- Placed under the feet, it helps to reduce pressure on heels.
- Can also be used simply as a pillow.

	Small	Large
<b>Code</b>	7007-1252-045	7007-1251-066
<b>Length</b>	45cm	60cm
<b>Width</b>	30cm	40cm
<b>Cover Code</b>	7007-1252-270	7007-1251-270



# Fitleg Evo

- Fitleg Evo has abduction module to limit friction around knee articulations and prevent leg-crossing in case of spasticity.
- Positioning device for proper orthopaedic alignment of lower limbs which prevents front sliding, friction and shear. Anatomic shape provides maximum comfort and stable positioning.
- Prevention of knee hyper-extension due to the anatomic shape.
- Viscoelastic foam combined with HR foam base to provide maximum comfort.
- Reduces pressure on heels area with support on calves and thigh.



	Fitleg Evo
Code	7007-1811-066
Length	58cm
Width	55cm
Height	12cm

# Ear Protection Cushion

- Comfortably supports the patient's head and relieves contact on the ear area in order to prevent bedsores.
- Comes standard with two cotton covers.



	One Size
Code	7007-4751-066
Length	30cm
Width	30cm



# Hemi-Care Cushion

- Supports and holds the upper limbs in a stable position. Both parts of the Hemi Arm are fixed together with Velcro strips.
- Maintains the arm in a position which cannot slide and reduces pressure on elbow area so that there is no sensation of tear strength in the shoulder. For users with kyphosis, the Hemi-Care cushion helps maintain the back straight.



	Small	Large
Code	7007-5522-045	7007-5521-066
Length	45cm	48cm long
Width	30cm	35cm



# CareWave Heel Cushion

- Fixes to the mattress at the heel area with an adjustable strap.
- Supports ankles and relieves pressure on the heel zone.

	One Size
Code	7007-5201-066
Length	90cm
Width	18cm

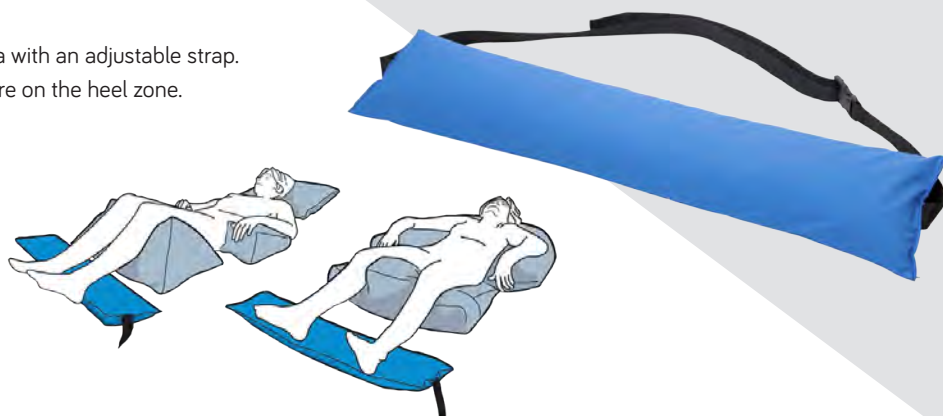

# CareWave Heel Bootie

- Designed to protect and prevent the feet/heels from injury and bedsores and to provide comfort whatever the patient's position.

	Small	Large
Code	7007-5302-045	7007-5301-067
Length of foot surface	25cm	30cm



# CareWave Delta

- Create lateral stability either alone, with one on each side, or an extra pillow to create a neutral position in the knee & hip joints.
- Supports and prevents the patient from falling forward from a decubitus position.
- Can be used in a semi fowler position, by placing under the legs.

	Small	Large
Code	7007-0552-045	7007-0551-066
Width	40cm	55cm
Depth	20cm	30cm
Height	20cm	30cm
Cover Code	7007-0552-270	7007-0551-270



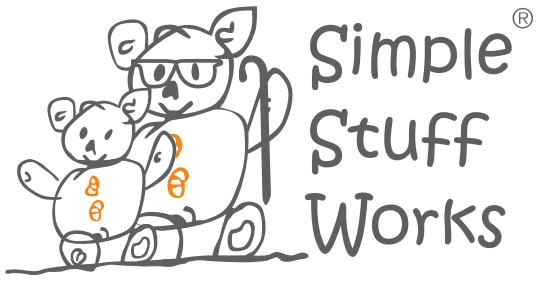

From our family to yours

The Simple Stuff Works way provides high quality education and therapeutic positioning equipment with an aim to eradicate the preventable problems associated with body shape distortion.

Simple Stuff Works advisors and colleagues are all highly experienced, having written some of the leading research into Postural Care and its effects. Medifab educators have been upskilled by these individuals and are ambassadors to promote protection of body shape.



Therapeutic positioning requires a comprehensive understanding from everyone involved if it is to be implemented successfully. Medifab with Simple Stuff Works is equipped to offer a range of training to support families, healthcare professionals and indeed anyone with an interest in therapeutic positioning. Our courses are accredited and license delegates to join a worldwide community of Postural Care Leaders with access to all our training materials and support.

Simple Stuff Works take pride in the fact that their equipment is silent, hygienic and simple to use. Training programs are available in Australia and New Zealand and will allow you to implement this powerful form of therapy as safely and as humanely as possible.





# Simple Stuff Works Packages

Packages are available in three sizes with common items

	Infant Package	Child Package	Adult Package
<b>Code</b>	7150-7001-C00	7150-7002-S00	7150-7003-S00
<b>User Age</b>	For infants from 0 to 5 years of age	For children from 5 to 12 years of age	For adults from 12+ years of age
<b>Package Includes</b>	<ul style="list-style-type: none"> <li>• 2x cot bed mesh</li> <li>• 2x cot toppers</li> <li>• 2x cot cotton sheets</li> <li>• 2x small lateral supports</li> <li>• 2x small wedges</li> <li>• Small horseshoe pillow</li> <li>• Simple Stabiliser Size 1</li> <li>• Travel bag</li> </ul>	<ul style="list-style-type: none"> <li>• 2x single bed mesh</li> <li>• 2x single toppers</li> <li>• 2x single cotton sheets</li> <li>• 2x medium lateral supports</li> <li>• 2x small wedges</li> <li>• 2x small lateral supports</li> <li>• Simple Stabiliser Size 2</li> <li>• Small Terry Towelling Pillow</li> <li>• Travel bag</li> </ul>	<ul style="list-style-type: none"> <li>• 2x single bed mesh</li> <li>• 2x single toppers</li> <li>• 2x single cotton sheets</li> <li>• 2x medium lateral supports</li> <li>• 2x medium wedges</li> <li>• 2x Large lateral supports</li> <li>• Large Terry Towelling Pillow</li> <li>• Travel bag</li> </ul>



## Simple Stuff Works Stabilising Mesh

- The base of the sleep system starts with a set of two layers of non-slip mesh. Supports are placed between the two layers around the individual to create the ideal position for them.
- One of the most hygienic bases for a positioning system being anti-microbial, complete with SteriTouch running through it, anti-mite, anti-fungal, entirely washable and conforms to Oeko-Tex Standard 100.
- Firmly holds any supports and is completely silent to use, making changes in position throughout the night as gentle and calm as possible.
- Can be used to also hold other pieces of equipment in place as well as holding the individual which means that the overall positioning system is very secure whilst allowing for easy changes in position.

	Cot Bed Size	Single Bed Size
<b>Code</b>	7150-7011-C00	7150-7012-S00
<b>Length</b>	<b>Base layer:</b> 1600mm <b>Top layer:</b> 1600mm	<b>Base layer:</b> 1790mm <b>Top layer:</b> 1810mm
<b>Width</b>	<b>Base layer:</b> 1530mm <b>Top layer:</b> 1080mm	<b>Base layer:</b> 1520mm <b>Top layer:</b> 990mm



## Simple Stuff Works Temperate Topper

- Pair of soft mattress toppers which are non-dynamic, neither cooling nor warming the individual so as not to interfere with their unique temperature regulatory system; an essential safety feature for those who find it difficult to control their own temperature.
- Used underneath the sheet on top of the layers of Stabilising Mesh.
- Made with a state-of-the-art material which is machine washable to 90°
- Wicks moisture away from the skin and allows air to circulate around an individual, helping to maintain a dry, temperate environment for them to rest in.
- Single size can also be used on larger beds.

	Cot Bed Size	Single Bed Size
<b>Code</b>	7150-7051-C00	7150-7052-S00
<b>Length</b>	1000mm	1000mm
<b>Width</b>	590mm	1000mm



## Simple Stuff Works Fitted Sheets

- Made from a beautiful material which is hard wearing but soft to ensure maximum comfort.
- Extra big and stretchy so that supports can be placed around an individual and the sheet will still conform to their body.
- Double bed sizes available on request.

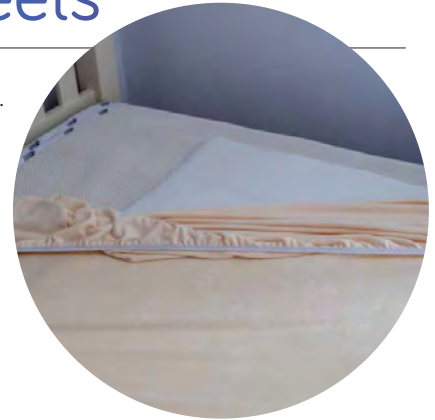

	Cot Bed Size	Single Bed Size	Queen Bed Size
Code	7150-7121-C00	7150-7122-S00	7150-7123-S00
Length	1400mm	1900mm	2000mm
Width	700mm	900mm	1500mm

## Simple Stuff Works Wedges

- Made with a specialist fibre and covered in a soft yet durable polyester-mix material.
- Fibre is highly breathable and wicks moisture away from the skin allowing the person to remain comfortable whilst reducing the risk of tissue damage.
- Tapered at one end to facilitate use in a variety of positions.



Also available in option for air mattresses designed to grip directly to the mattress surface.

See scripting and ordering guide for more information.

	Small (Foam)	Small (Air)	Medium (Foam)	Medium (Air)
Code	7150-7351-000	7150-7326-000	7150-7352-000	7150-7327-000
A	220mm	320mm	360mm	310mm
B	110mm	140mm	80mm	110mm
C	110mm	110mm	90mm	130mm

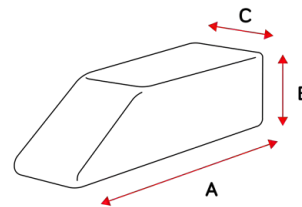

## Simple Stuff Works Padded Lateral Supports

- Perfect for providing firmer support for an individual using our therapeutic positioning equipment.
- L-shaped with soft, washable, removable pads which cover them.
- Positioned between the two layers of stabilising mesh which holds them in place securely.
- Can also be used to stabilise other support items such as leg supports or pillows.

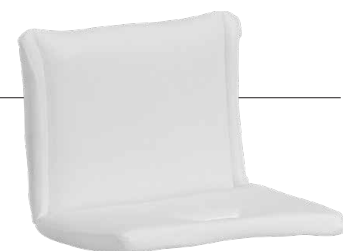

Also available in option for air mattresses designed to grip directly to the mattress surface.

See scripting and ordering guide for more information.

	Small	Small (Air)	Medium	Medium (Air)	Large	Large (Air)
Code	7150-7201-000	7150-7211-000	7150-7202-000	7150-7212-000	7150-7203-000	7150-7213-000
A	180mm	180mm	220mm	220mm	280mm	280mm
B	120mm	120mm	140mm	140mm	220mm	220mm
C	180mm	180mm	220mm	220mm	280mm	280mm

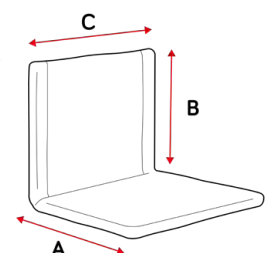

# Simple Stabiliser

- Simple, yet effective, the Simple Stabiliser is a multi-adjustable leg support designed to support the pelvis and the hips.
- The soft base allows the legs to gently relax within it and provides a gentle, passive stretch overnight.
- The soft support at the side also prevents external rotation of the hips and keeps the legs in a neutral and secure position.

Supportive leg positioning accessory which provides therapeutic positioning to the lower limbs.



The Simple Stabiliser aligns the legs therapeutically, correcting habitual, unsupported positions in supine lying. It is primarily intended for therapeutic positioning in the lying posture and is commonly used by individuals with movement difficulties. When used consistently, it can help in protecting and restoring an individual's body shape. Examples of postures that can be avoided with the assistance of the Simple Stabiliser include:

- Windsweeping to the right or left
- Internally rotating both hips
- Externally rotating both hips

## FUNCTIONAL BENEFITS

- **Therapeutic Leg Alignment:** The Simple Stabiliser promotes therapeutic leg alignment, correcting habitual or unsupported positions in supine. It helps prevent conditions like 'windsweeping' and hip internal/external rotation.
- **Pelvic Stability:** Worn above the knees, the Simple Stabiliser stabilises the pelvis and hips, maintaining a neutral, supine position for extended periods.
- **Post-Surgery Support:** This device aids in post-surgery immobilisation to prevent contractures by maintaining therapeutic leg alignment.
- **Moisture Management:** Featuring a cotton terry towelling cover and specialised moisture-wicking fiber filling, the Simple Stabiliser wicks moisture away from the body, promoting skin health and aiding in temperature regulation.

	Size 1	Size 2	Size 3	Size 4
With Breathable Inner & Terry Cotton Outer	7150-7341-000	7150-7342-000	7150-7343-000	7150-7344-000
With Wipeable Inner	7150-7345-000	7150-7346-000	7150-7347-000	7150-7348-000
Height	11cm	19cm	25cm	28cm
Depth	11cm	35cm	40cm	40cm
Width	42cm	46cm	65cm	65cm
Approx. Leg Circumference	25cm	35cm	55cm	60cm
Suggested Age Range	2 - 4yrs	2 - 10yrs	5 - 13yrs	13 - Adult
Spare Terry Cotton Cover	7150-7221-000	7150-7222-000	7150-7223-000	7150-7224-000
Spare Wipeable Inner Cover	7150-7225-000	7150-7226-000	7150-7227-000	7150-7228-000

# Simple Stuff Works Roll Pillows

- Made from a soft fibre and covered in a comfortable yet durable polyester-mix material.
- Can be used for a variety of different functions and is normally used to support the user's legs.
- Can be used between the two layers of stabilising mesh, or on top of the sheets



	Small	Large
With Breathable Inner & Terry Cotton Outer	7150-7851-000	7150-7852-000
With wipeable incontinence inner & terry cotton outer	7150-7855-000	7150-7856-000
Spare Terry Cotton Cover	7150-7857-000	7150-7858-000
Width (A)	150mm	180mm
Length (B)	400mm	500mm

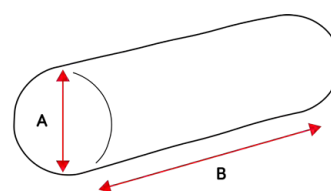

# Simple Stuff Works Side Lying Leg Support

- Designed to protect the hips and pelvis when a person is lying on their side.
- The leg channel creates a perfect place for the top leg to lie and the bottom leg wraps gently around the outside.
- When combined with lots of support along the person's back, a supportive side lying position can be achieved.
- Perfect for individuals who need to lie on their side for safety reasons.



	Size 1	Size 2	Size 3
<b>Standard</b>	7150-7971-000	7150-7972-000	7150-7973-000
<b>Wipeable inner/terry outer</b>	7150-7981-000	7150-7982-000	7150-7983-000
<b>A</b>	270mm	400mm	400mm
<b>B</b>	380mm	560mm	610mm
<b>C</b>	280mm	340mm	400mm
<b>D</b>	80mm	100mm	110mm
<b>E</b>	130mm	200mm	150mm
<b>F</b>	80mm	90mm	70mm

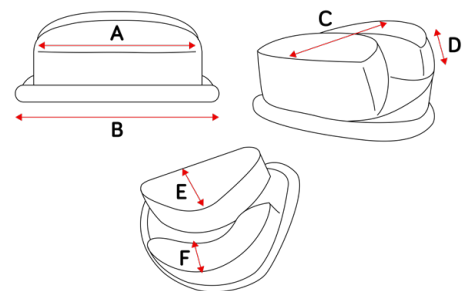

# Simple Stuff Works Foot Support

- Designed to hold the feet in a neutral position for long periods of time.
- Made from the same fibre as the Temperate Toppers so they help to keep the feet feeling fresh whilst they are protected from falling forwards or rotating.
- Terry towelling outer makes for a comfortable and soft feel on the feet.
- Easy clip system makes it easy to put on and take off.



	Size 1	Size 2	Size 3
<b>Code</b>	7150-5351-000	7150-5352-000	7150-5353-000
<b>A</b>	210mm (max)	250mm (max)	300mm (max)
<b>B</b>	200mm	220mm	300mm

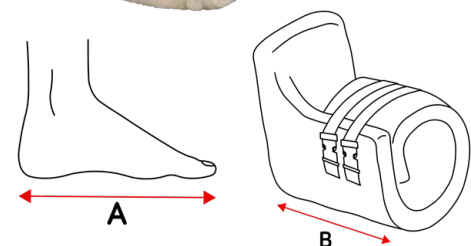

# Simple Stuff Works Neck Support Pillow

- Great option for supporting an individual's neck.
- Made from a soft fibre and covered in a comfortable yet durable polyester-mix material.

	Neck Support Pillow
<b>Code</b>	7150-4050-000
<b>A</b>	350mm
<b>B</b>	300mm

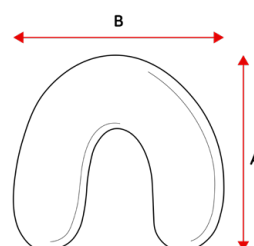

# Simple Stuff Works Horseshoe Pillow

- Made from a soft fibre and covered in a comfortable yet durable polyester-mix material.
- Can be used for a variety of different functions and is normally used to support the user's legs.
- Can be used between the two layers of stabilising mesh, or on top of the sheets.

	Small	Large
Breathable inner/terry outer	7150-7711-000	7150-7712-000
Wipeable inner/terry outer	7150-7721-000	7150-7722-000
A	460mm	500mm
B	190mm	200mm

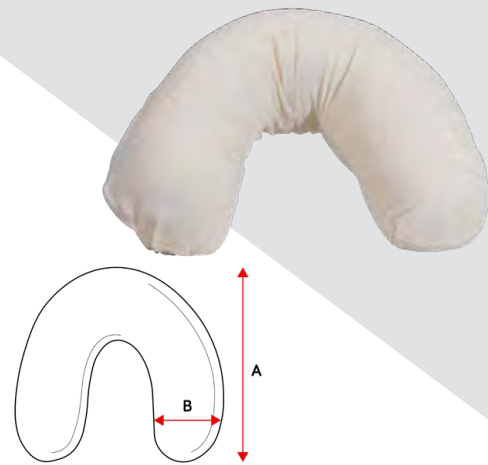

# Simple Stuff Works Terry Towelling Pillow

- Universal supportive positioning pillow to provide the extra support where required.
- Can be used between the two layers of stabilising mesh, or on top of the sheets.
- Covered by a soft and comfortable, yet durable terry towelling cover.

	Small	Large
Code	7150-7501-000	7150-7502-000
Length	480mm	680mm
Width	350mm	450mm



# Dreama Positioning

- Combined pressure reducing mattress and postural support system, suitable for children and adults.
- Supporting at risk children and adults to achieve supported positioning for lying, helping to reduce muscle tone and contribute to better quality of sleep.
- Dreama can be used to help reduce the risk of body shape changes and deformity for those who are at risk due to their condition or diagnosis.
- Designed to be very easy to keep clean and keep hygienic.
- Glide-lock technology means configurations can be changed with minimum disruption to the user. This key feature helps to accommodate and correctly position posture overnight, whilst maintaining a high level of comfort.



- Contour the flexible aluminium base for a custom lying surface. Suits profiling beds, rolls, wedges.

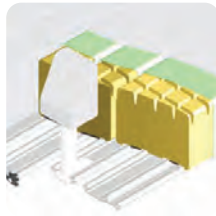

- Quiet with no noise or disturbance when adjusting positions due to Glide-lock supports.

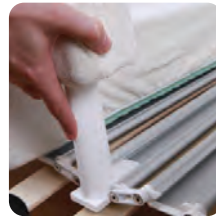

- Quick, simple assembly, and exceptional flexibility with numerous accessories.



# Dreama Base & Mattress

- Includes flexible aluminium base, full set of mattress cells, full set of neutral covers, and pair of anchor straps.
- Pressure-reducing 15cm deep modular mattress removes the need for overlays.
- Individual covers for each cell mean that if soiled, only the covers that need washing can be removed and replaced saving time and energy.
- Spaces between mattress cushions allow airflow, helping to maintain a comfortable temperature. Covers are upholstered in fire-retardant, water resistant, 2-way stretch, antibacterial fabric for infection control.
- Add locking feet (#7120-6100-000) to mark the position where an accessory should be placed. Locking feet keep accessories in place for users with strong movement.

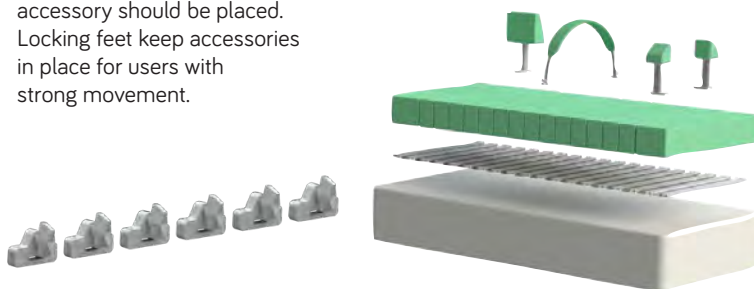

	Cot	Single bed
<b>Code</b>	7120-0010-000	7120-0020-000
<b>Age range</b>	4mths-5yrs	9mths - adult
<b>Overall size</b>	56 x 120cm	90 x 190cm
<b>Overall height</b>	17cm	17cm
<b>Single mattress cushion</b>	56 x 9.5 x 15cm	90 x 9.5 x 15cm
<b>Double mattress cushion</b>	56 x 19.5 x 15cm	90 x 19.5 x 15cm
<b>Number of mattress units</b>	8 single, 2 double	15 single, 2 double
<b>Max user weight</b>	80kg	110kg

## Dreama Positioning Pads

- Made from comfortable and hygienic PU. Positioning Pad Combos include angle-adjustable positioning pad, memory foam pad, and towelling cover.
- Use to position the trunk, arms or legs.
- Slimline Support option is an alternative slimmer support than the standard positioning pads.
- Removable memory foam pad (shown in green) for extra comfort and pressure relief. Ideal for support of areas with bony prominences.
- Additional covers available for all positioning pads in white towelling.

	Pad Combo	Spare Cover	L	W	H
<b>Slimline</b>	7120-3250-500	7120-3280-000	-	108mm	159mm
<b>Small</b>	7120-3251-500	7120-3281-000	102mm	83mm	95mm
<b>Medium</b>	7120-3252-500	7120-3282-000	102mm	83mm	140mm
<b>Large</b>	7120-3253-500	7120-3283-000	203mm	89mm	165mm
<b>X large</b>	7120-3254-500	7120-3284-000	203mm	89mm	267mm

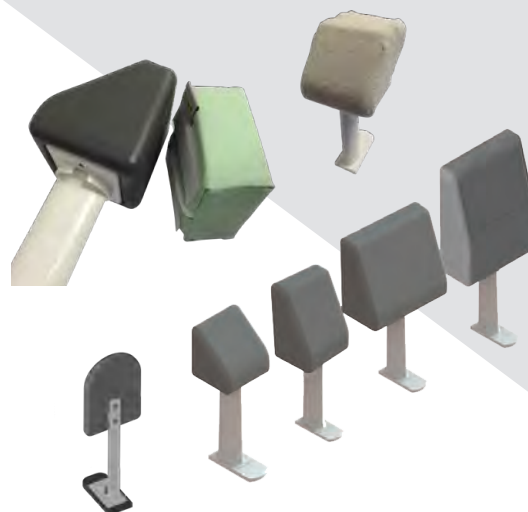

## Dreama Abduction Block

- Can be used individually or in pairs to ensure the hips are abducted and the body is straight.
- Ideal for users with increased abductor tone or where positioning into hip abduction is required.

	Small	Medium	Large
<b>Code</b>	7120-1601-000	7120-1602-000	7120-1603-000
<b>Cover</b>	7120-1661-000	7120-1662-000	7120-1663-000
<b>Width</b>	130mm	130mm	240mm
<b>Depth</b>	200mm	200mm	300mm
<b>Height</b>	200mm	250mm	300mm

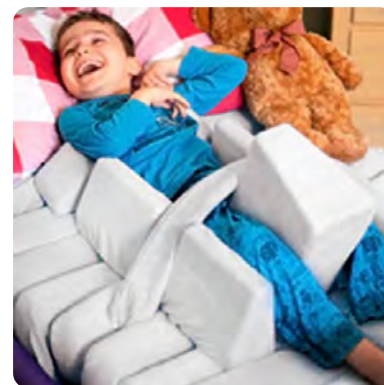
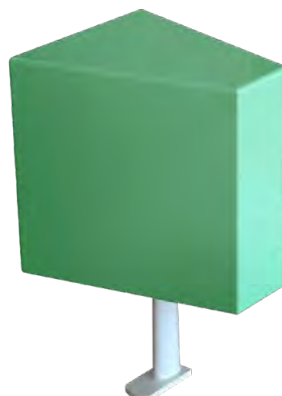

## Dreama Knee Blocks

- Comfortably holds the knees in a specified position.

	Small	Large
<b>Code</b>	7120-1751-000	7120-1753-000
<b>Cover</b>	7120-1781-000	7120-1783-000
<b>Width</b>	77mm	108mm
<b>Depth</b>	102mm	102mm
<b>Height</b>	51mm	102mm



# Dreama Side Lying System

- Complete system includes a combination of positioning pads, supportive strap and foam support pad. The straps attach to standard Dreama positioning pads.
- Side Lying Support Strap can be used to secure the upper leg when side lying. Includes fittings to fit to two standard positioning pads.
- Side Lying Foam Pad is available in different thicknesses to encourage neutral hip positioning of the top hip in side lying.



	Size 1	Size 2	Size 3
<b>Lying Pad</b>	7120-1851-000	7120-1852-000	7120-1853-000
<b>Pad Cover</b>	7120-1861-000	7120-1862-000	7120-1863-000
<b>Pad Width</b>	345mm	445mm	540mm
<b>Pad Depth</b>	120mm	140mm	159mm
<b>Pad Height</b>	35mm	51mm	76mm
<b>Strap Code</b>	7120-1872-000		
<b>Strap Cover</b>	7120-1882-000		
<b>Strap Dims</b>	140mm wide x 388mm long x 57mm high		

# Dreama Positioning Hoop

- Functional item which keeps covers away from the body.
- Allows movement within a limited range for a comfortable night's sleep.

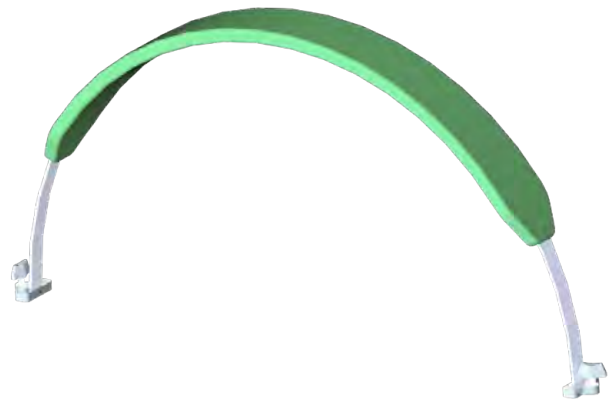

	Small	Medium	Large
<b>Code</b>	7120-1951-000	7120-1952-000	7120-1953-000
<b>Cover</b>	7120-1961-000	7120-1962-000	7120-1963-000
<b>Width</b>	70mm	70mm	70mm
<b>Length</b>	432mm	560mm	700mm
<b>Height</b>	15mm	15mm	15mm

# Dreama T-Roll

- Versatile, height adjustable accessory. Supports the knees, reduces abdominal pressure and prevents scissoring and wind-sweeping.
- Each leg support is height adjustable and the Medial Knee Support can be removed.

	One Size
<b>Code</b>	7120-1771-000
<b>Cover</b>	7120-1761-000
<b>Width</b>	527mm
<b>Length</b>	108mm
<b>Height</b>	121mm

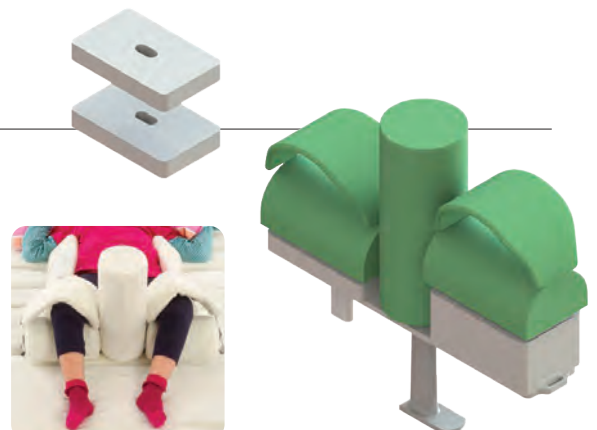



# Resources to share knowledge, assist with assessment and help find the best solution to support your clients in lying!

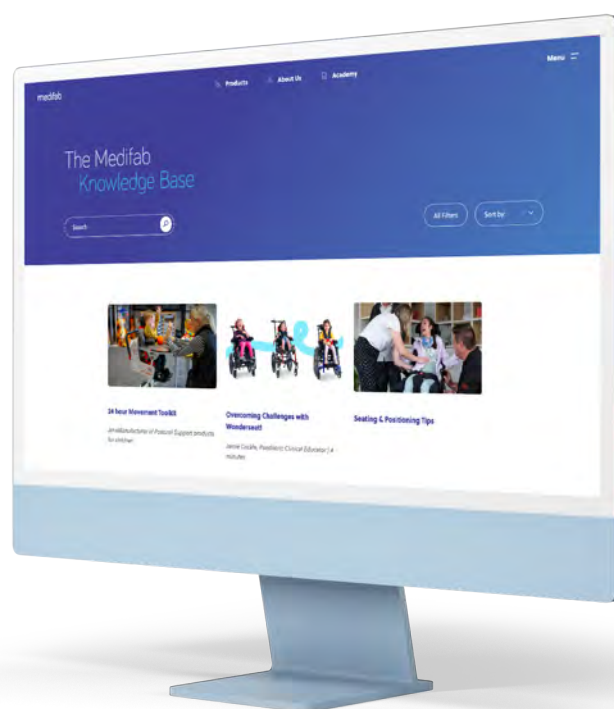
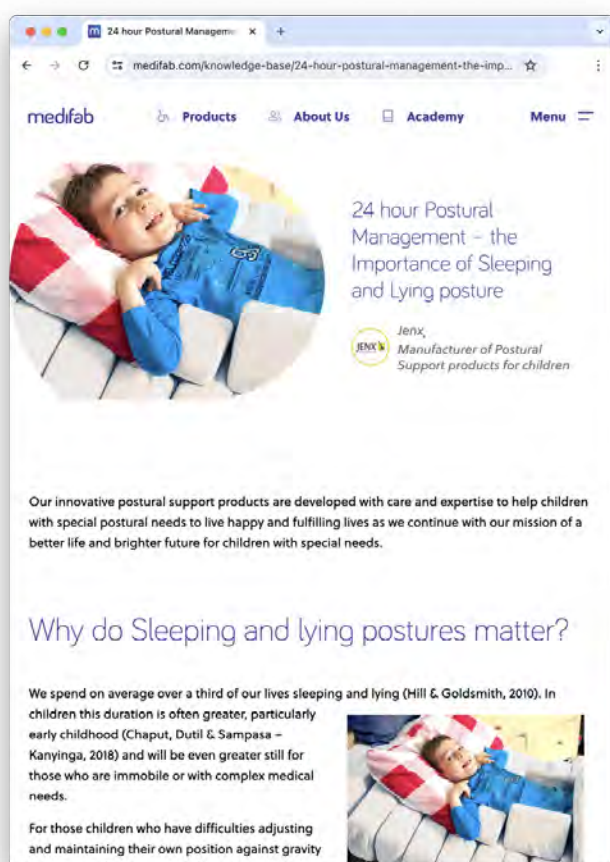

Explore our extensive online resources available to download at [medifab.com/knowledge-base](https://medifab.com/knowledge-base)



Better nights,  
better days



## Beds



With the Safe Surround Bed options, the product user and guardian can experience a better night's sleep, providing a safe and secure environment. Get the rest you need with safety you can trust.

---

Safe Surround Genie Bed	108
Safe Surround Plus Bed	109

---

# Safe Surround Genie Bed

The Safe Surround Genie bed is for children and adults that can be found in dangerous positions due to movement during the night and need a safe environment for greater containment.

## Superior Nursing Care for Children and Adults

**Perspex panels** provide free eye contact with carers, and the individual can take in what is going on around them

**High quality craftsmanship:** durable Beech timber with attractive aesthetics



For **carers in wheelchairs** Genie provides ample clearance of up to 74cm

Sufficient clearance for **hoist transfers**

## Standard Features



Adjustable lying surface including 4 section profile sleeping platform, Standard foam mattress, 4 locking castors.



Raise mattress level high to assist carers when tending to the client.



Lower mattress level to enable independent transfers.

## SAFETY FEATURES FOR GENIE & PLUS BEDS

- Safe interior to prevent entrapment of head or limbs.
- Special door locking system prevents the doors being opened from the inside.
- Unique door hinge system that doesn't entrap fingers.
- High quality fittings and locking mechanisms.
- Power cut-off plug. When the hand switch is not activated (power disconnected state) all electrical components of the bed are disconnected from the mains and therefore no electricity is used. Electric and magnetic fields in the bed are prevented.
- Maintenance-free DC motors and manual safety switch.
- Emergency lowering in the case of power failure.
- Special wooden surface coating that seals the surfaces for maximum hygiene.
- Sweat and saliva resistant wood treatment in accordance with DIN 71-3 Children's Toys Safety Act.

## OPTIONS

**Mattress Incontinence Cover**  
7956-0026-000



**Pressure Relief Foam Mattress**  
7956-0011-051



**Internal Padding** as Required. Velcro attachment.



Code	Door Height	Clearance Height (For Wheelchair)	Weight Limit	Inside Dimensions	Overall Height	Lying Height	Outside Dimensions
7959-0016-000	98cm	74cm	150kg	200 x 90cm	Min. 137cm	Min. 42cm	223 x 101cm
					Max. 197cm	Max. 102cm	

# Safe Surround Plus Bed

The Safe Surround Plus beds are for children and adults that are able to pull themselves to kneeling and/or standing positions and require higher bed doors to provide a safe environment.

## Safe environment for active people with challenging behaviour

Designed for those who have **restless motor functions** or **seriously disruptive behaviours**

**High quality** craftsmanship: durable Beech timber with attractive aesthetics



**Extremely stable** and strong construction to withstand forces

Lower the mattress level to enable **self-transfers**

## DOOR SYSTEM

Two handed exterior door release system with special locking system that prevents the doors being opened from the inside.



## PROFILING SLEEP PLATFORM

Assists physical needs of the user, and height adjustable to achieve ergonomic height for the parent/carer.



## OPTIONS

**Mattress Incontinence Cover**  
7956-0027-000

**Pressure Relief Foam Mattress**  
7956-0011-051



**Internal Padding** as Required. Velcro attachment.



## Standard Features



Roomy internal measurements and door height options to protect almost any active child from harming themselves.



- Height adjustable lying surface
- 5 section profiling sleeping platform



- Standard foam mattress
- External door locking bar

Code	Door Height	Weight Limit	Inside Dimensions	Overall Height	Lying Height	Outside Dimensions
7953-0008-000	135cm	150kg	200 x 100cm	184cm	55cm - 95cm (top of mattress)	215 x 117cm (with locking bars in place)
7953-0011-000	170cm			220cm		





# medifab

[solutions@medifab.com](mailto:solutions@medifab.com)

[medifab.com](https://medifab.com)



THIS RESOURCE BELONGS TO: