

Whitmyer













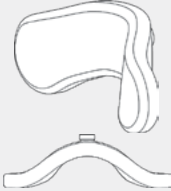



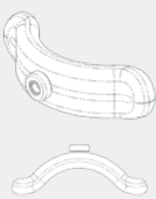

HEAD SUPPORT SOLUTIONS

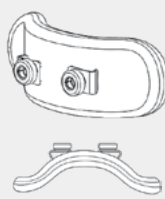
Distributed by **medifab**[®]

SCRIPTING AND ORDERING GUIDE









Whitmyer Ordering Guide

STEP 1: Select Pad



PLUSH					
					
19" Wide	14" Wide	10" Wide	8" Wide	6" Wide	
9" High	5" High	5" High	5" High	4" High	
1480-4119-281	1480-4114-281	1480-4110-281	1480-4108-281	1480-4106-281	
ADJUST-A-PLUSH			DUAL MOUNT PLUSH		
					
Adjust-A-Plush Standard	Adjust-A-Plush Medium	Adjust-A-Plush Narrow	19" Dual Mount Plush	14" Dual Mount Plush	12" Narrow Plush
8" - 18" Wide	7" - 16" Wide	6" - 14" Wide	19" Wide	14" Wide	12" Wide
5" High	4" High	3" High	9" High	5" High	3" High
1480-4330-281	1480-4320-281	1480-4310-281	1480-4120-281	1480-4115-281	1480-4112-281
CONTOURED CRADLE			CONTOURED C-PLUSH		
					
Large	Medium	Small	Large C-Plush	Medium C-Plush	Small C-Plush
13" Wide	10" Wide	8.5" Wide	7" Wide	6" Wide	5" Wide
7.5" High	6" High	5.5" High	5" High	4.5" High	4" High
1480-4231-281	1480-4221-281	1480-4211-281	1480-4232-281	1480-4222-281	1480-4212-281

NOTE: Pad Cover Material is LYCRA

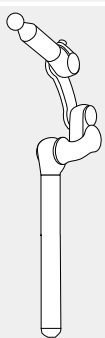
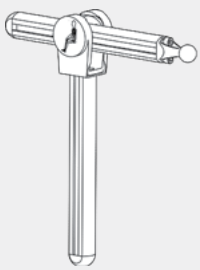
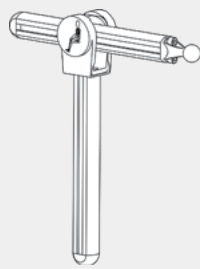
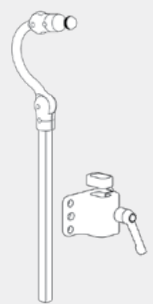
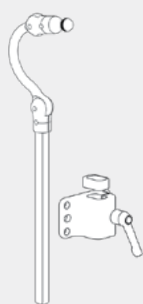
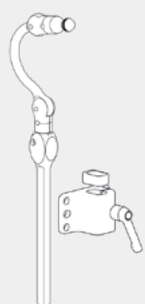
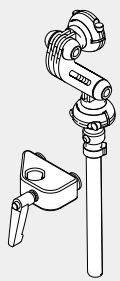
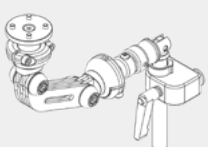
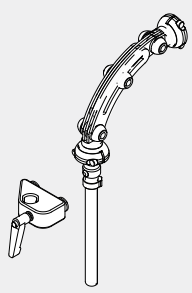
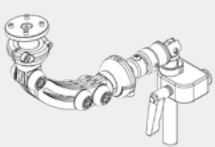
STEP 2: Select Hardware System



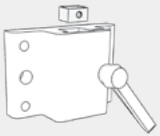

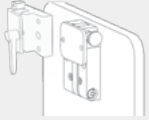
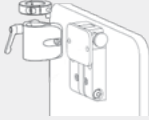
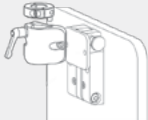



HARDWARE SYSTEM				
				
AXYS	LINX 4"	LINX 8"	LINX 10"	LINX 15"
1480-4913-100	1480-4961-004	1480-4961-008	1480-4961-010	1480-4961-015
				
LINX2 4"	LINX2 8"	LINX2 10"	LINX2 15"	PRO PEDIATRIC
1480-4962-004	1480-4962-008	1480-4962-010	1480-4962-015	1480-4934-101
				
PRO ADULT	COBRA XTRA PEDIATRIC	COBRA XTRA ADULT	COBRA XTRA FLIPBACK	STYLO 160
1480-4934-100	1480-4923-102	1480-4923-103	1480-4922-100	1274-1282-500
				
STYLO FLIPBACK 160	STYLO 260	STYLO FLIPBACK 260		
1274-2252-500	1274-1252-500	1274-2282-500		

STEP 3: Select Mount Bracket

MOUNT BRACKET					
	AXYS	LINX / LINX2	PRO	COBRA	STYLO
Detachable				COBRA XTRA Hardware System includes detachable mounting bracket.	STYLO 160 and STYLO 260 Hardware Systems include detachable mounting bracket.
	1480-4911-100	1481-M2300	1480-4931-100		
Swing-Away				Select COBRA XTRA Flip Back Hardware System for swing-away capability.	Select STYLO FLIP BACK 160 or STYLO FLIBACK 260 Hardware System for swing-away capability.
	M5000	M5000	M5000		

Lateral Facial Support Ordering Guide

STEP 1: Select Facial Pad

							
Spot	Standard	Long	Curved	Oval	Large-C	Med-C	Small-C
1481-PL10L	1481-PL15L	1481-PL20L	1480-4612-281	1480-4613-281	1481-PL30L	1481-PL35L	1481-PL40L

STEP 2: Select Stem

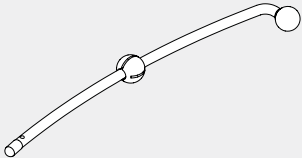
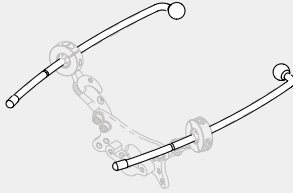
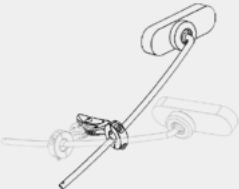
STEMS		
		
Unilateral	Bilateral	Anterior
1481-LM1010	1481-LM1010 x 2	1481-LM1096



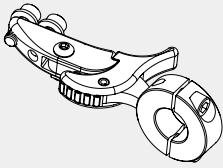
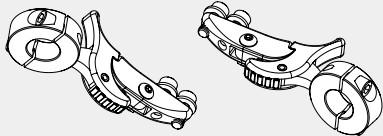
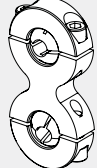

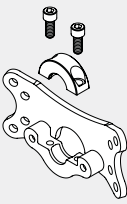
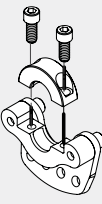

STEP 3: Select Mount

UNILATERAL	BILATERAL	ONE PER SIDE
		
Swing-Away Mount	Swing-Away Mount	Infinity
1481-LM115	1481-LM115 x 2	1481-242161

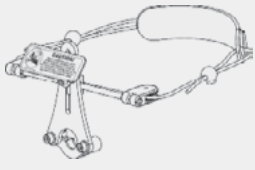
STEP 4: Select Adaptor

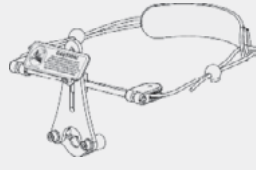
PLUSH	CONTOURED CRADLE
	
Plush Lateral Interface Plate	Contoured Cradle Lateral Interface Plate
1481-LM-PL	1481-LM-CCS

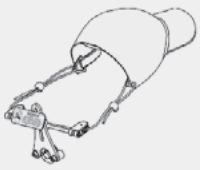
STEP 5: Select Anterior Support (Optional)

ADULT			
			
Dynamic Forehead Strap	Dynamic Forehead Strap Rigid	Strap Cap (Black)	
1480-4822-000	1480-4832-000	1480-4842-099	
PEDIATRIC			
			
Dynamic Forehead Strap	Dynamic Forehead Strap Rigid	Strap Cap (Red)	Strap Cap (Blue)
1480-4821-000	1480-4831-000	1480-4841-020	1480-4841-060

Required For STEP 5

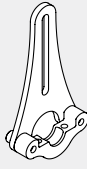
INTERFACE

Anterior Support Interface
1481-D1010

medifab®

Distributed by Medifab Ltd

22 Detroit Drive
Rolleston 7675
New Zealand

+64 3 307 9790

solutions@medifab.com

www.medifab.com



DISTRIBUTED BY:

Script: Whitmyer_20201123