

CentroGlide User Manual

2021 VERSION



IMPORTANT

For your safety and comfort read carefully and understand all of the features prior to using your new Centro Powerchair.

Misuse may result in electrical or mechanical damage.



Table of Contents

Section 1	Introduction	3
Section 2	Identifying Parts on your Wheelchair	4
Section 3	Warnings for Carer and Occupant	5
Section 4	Joystick and Controller Operation	10
Section 5	User training and setup	17
Section 6	Battery Maintenance and Charging	19
Section 7	Care and maintenance	23
Section 8	Trouble shooting	26
Section 9	Precautions for Controller use	27
Section 10	Transfer to and from your wheelchair	29
Section 11	Vertical Lift Seat Option	30
Section 12	Warranty	31
Section 13	Spare Parts	32
Section 14	Puncture Repair	33
Section 15	Technician Service Only	35
Section 16	Wheelchair Occupant Vehicle Transport	37

Note: This manual covers the basic PG controller operation in this manual.
A more comprehensive PG Manual can be downloaded from
www.glide.com.au/products

Thank You For Choosing The CentroGlide Wheelchair

This wheelchair is a **Class B** type wheelchair and is designed for Indoor/Outdoor use.

Maximum User Weight **175 kg AS-3695**

Maximum User Weight **250 kg AS-3695 (Bariatric version)**

Maximum user weight for Occupant Vehicle Transport **159kg AS-3696:19**

Transporting users over 159kg requires special equipment.

An Australian designed and manufactured product, which complies with AS-3695 – 175 kg/250 kg and Crash Tested to AS-3696:19.

With proper care and operation your wheelchair will provide years of trouble free mobility.

Please take the time to familiarise yourself with the functions and features of your power chair by reading this owner's manual. If you have any queries about the functions of the chair you can call Glide Products or your nearest Glide Products dealer.



Warning. Means you must read.

If you have a Vertical Lift model, it is essential you read and fully understand Section 11 before use.

The CentroGlide Wheelchair

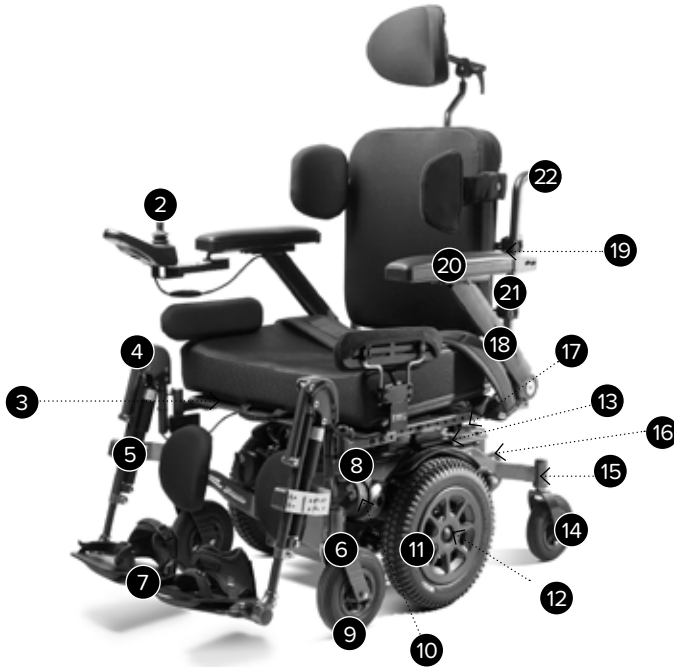

Identifying Parts on your Wheelchair (Fig 1)

- | | |
|-----------------------------------|-----------------------------------|
| 1. Attendant Joystick (not shown) | 12. Drive Wheel Clutch (Optional) |
| 2. Joystick | 13. Attendant Brake |
| 3. Seat Pan | 14. Castor Wheel (Rear) |
| 4. Leg Rest Hanger | 15. Rear Suspension Arm |
| 5. Leg Rest Latch | 16. Rear Vehicle Tie Down Point |
| 6. Front Suspension Arm | 17. Circuit Breaker (Reset) |
| 7. Foot Rest (Adjust Angle Shown) | 18. Armrest (Flip-Up) |
| 8. Front Vehicle Tie Down Point | 19. Actuator (Recline) |
| 9. Castor Wheel (Front) | 20. Armrest |
| 10. Motor Brake Release | 21. Back Cane |
| 11. Drive Wheel | 22. Hand Grip |

SECTION 3 | WARNINGS

To The User

1. Before using this chair, obtain advice and training from your Health Professional.
2. Each chair is custom designed to suit individual needs.
Take time to become familiar with each feature before you begin driving.
3. Depending on your level of function and ability, you will need to develop your own methods for safe use.
4. Understanding the environment where the wheelchair will be used will help identify potential hazards and how to avoid them.
5. Read this manual in full before operating chair.
6. When traversing curbs or steps always approach square on.
Never attempt angled approaches as this may damage castors.
7. **Never drive wheelchair onto stairs or escalators.**

To The Carer

1. You must read this manual and follow all the instructions in each section as they also apply to you.
2. Never use power operated options such as Vertical Lift, Power Elevators unless occupant and bystanders have hands well clear of operation
3. Drive Clutches or Motor Brakes should be engaged at all times while occupant is seated.
When drive clutches are disengaged there is no braking when manoeuvring wheelchair
4. To manually push the chair you must make sure that you have control over the wheelchair before releasing the motor drive clutch. Only manually manoeuvre wheelchair on level ground while occupant is seated in wheelchair. Never manually manoeuvre wheelchair up and down ramps whilst occupant is seated in wheelchair.
5. You must develop an understanding of the occupants ability to develop safe methods best suited to your ability
6. Only use the push handles to move chair. They are specifically designed for this purpose
7. When helping the occupant overcome an obstacle you must:
 - Learn safe methods from your health professional
 - Explain clearly to the occupant what you are about to do and what they are required to do
 - When traversing curbs or steps always approach square on.
Never attempt angled approaches as this may damage castors.
8. **Never take the wheelchair on to stairs or escalators.**



Environment Conditions

The Glide Rehabilitation Products Power Chair has been designed and tested with user safety, as its prime consideration.

The “Active Posi Trak” (APT) Suspension System has been designed to automatically adjust to uneven surfaces and changes in height, allowing all six wheels to stay in contact with the ground under most conditions. This feature provides improved stability and increased traction on drive wheels in demanding situations.

Even though the “Active Posi Trak” System improves manoeuvrability and stability, this does not negate the effect or take into account, circumstances, which put the wheelchair outside the specified operating conditions for which it was designed and tested.

It is important that the user takes due care and understands the limitations within the environment that the chair will be operated.

As a guide only, the following is a brief list of scenarios that could affect the stability of the chair and need to be considered when driving chair:

- Always turn the controller off when parked. Even it is only for a short time as this will prevent accidental movement of chair or release of park brakes.
- The Wheelchair must remain in the **Engaged Drive Mode** at all times unless manually manoeuvring the wheelchair.
- Traction could be lost on inclined or decline if wet, oily or grassy surfaces. Take extra care and drive slowly on these surfaces.
- Extreme Tilting and reclining must be done on level ground ONLY.
- Chairs fitted with Tilt and Recline features should NOT be driven with these features in an extreme Tilt or Reclined position. Driving in a Tilted or Reclined position can affect stability and your vision.
- Never drive your chair on a wet, oily or icy covered ramp or slope
- Stop if one or both drive wheels loses traction
- Never traverse railway lines without someone in attendance
- Wheelchair should not be driven in heavy rain.
- Never use your chair in a shower, swimming pool, sauna, ocean or lake.
- If your environment has many steep obstacles, always have someone in attendance to assist you.
Avoid driving your wheelchair in sand or over rough surfaces.
- Apart from getting stuck you may also cause damage to wheels, bearings, gearboxes and motors.
- Maximum safe slope – facing up slope 15 degrees
- Maximum safe slope – facing down slope 15 degrees
- Curb climbing should not exceed 80mm when level. Do not climb if already on slope.
- Curb descending should not be more than 100mm when level.

- Do not descend if already on slope.
- Always approach curbs square. Never on an angle. Castor will spin and lock if approach angle is not 90 degree.
- Whilst driving, the ON/OFF switch on the controller should only be switched OFF in an emergency. The wheelchair will come to a fast controlled stop rather than sudden stop.

Ramps & Inclines

When your chair is on a ramp or incline the centre of balance of your chair will change.

Your chair is less stable when on ramps or inclines and should not be used unless you feel it is safe to do so. If in doubt have someone with you.

Do not use the chair on a slope of greater than 15 degrees.

When **ascending a ramp**: (going up)

- Make sure power tilt seat is in the down or flat position and the backrest is in the upright position.
- Never attempt climbing ramps with high degree of seat tilt.
- Approach the ramp or incline straight on. Do not approach on an angle (cut the corner)
- Make sure that you are in the centre of the ramp and that the ramp is wide enough for your wheelchair
- Do not use ramp if you feel that a wheel may drop off the side.
- Do not veer or turn while on ramp. This may cause chair to tip and a fall may result.
- Drive wheelchair at a slow, steady speed. Keep chair moving.
- Return tilt and recline to normal driving position when back on level ground.

When **descending a ramp**: (going down)

- You should raise the power seat tilt to a suitable angle to compensate for the ramp angle. The seat angle should be in a near level position when on the ramp or even better slightly raised. This will reduce the chance of your body falling forward when travelling down a ramp.
- Re-adjust seat tilt angle to your normal drive position when back on level ground.
- Always use the centre of the ramp.
- Do not veer or turn while on ramp.
- Drive wheelchair at a slow steady speed. Do not allow chair to accelerate over normal speed. Centre the joystick to allow it to slow down or stop.
- Never use attendant brakes to slow or stop the chair. This may cause the chair to veer or change direction erratically.

Electro-Magnetic Interference

EMI (Electro-Magnetic Interference) comes from Radio Waves like Cellular phones, CB Radios and Two Way Radio. Other sources include Transmitters from TV and Radio stations but are unlikely to interfere unless in close proximity to the transmitter.

EMI can cause your wheelchair to behave erratically or even more so, release brakes or move by itself unexpectedly. If this happens, immediately turn your wheelchair Off.

Before continuing, the user must be confident that the system is performing normally. If not, turn wheelchair Off and contact your carer or Glide Rehabilitation Products Agent.

Although Glide has not had any reported instances of EMI, there has been anecdotal evidence over many years that EMI can have an impact on power chair controllers.

Controllers

Your wheelchair has been supplied with a fully programmable controller, which has the ability to fine-tune many driving parameters using special equipment and a PC.

At time of specification your chair would have been programmed to best suit your individual function and ability.

Drive the chair in the mode and speed level that best suits the environment so as not to cause injury to yourself or others.

Have an authorised Glide Rehabilitation Products agents make adjustments to the controller if the chair is not performing to your satisfaction. There are no controller adjustments that can be made by the user or carer apart from speed level selection.

Safety Performance Check

Make sure the chair operates as it is designed to do.

If there is a change in the performance of the wheelchair or in your functional ability, contact your nearest Glide Rehabilitation Products agent to reprogram the control settings to match your needs. It is advisable to have these settings checked annually.

Check for any uncharacteristic noises, vibration or any difficulty in its use.

If a problem is found, notify your carer and Glide Product Agent for repair or advice on how to repair. Do not drive it if your safety is at risk.

Make sure that the batteries are fully charged before operating. Make sure all tyres are inflated to recommended pressures and in good condition.

Make sure all accessories are secure and in correct position.

Check that the electronic brakes work correctly. (When chair is switched ON with drive clutch engaged and hand off the joystick, the wheelchair should not be able to be pushed.)



Wheelchair Modifications

Never make any modifications or use non-approved Glide Products parts on your power chair. Doing so may cause a safety hazard and could void Warranty.

Unauthorised changes could constitute as re-manufacturing of the power chair. This voids any warranty. The person or group who make the changes will have full liability of the power chair.

SECTION 4 | OPERATING YOUR POWERCHAIR

PG Controller

Your new Power Chair will be supplied with a PG control system as standard unless otherwise specified. In most cases the Joystick module will be a LCD screen type as per image below. You will have been given instructions on how to operate your controller at time of trial and on delivery. As most power wheelchairs are setup with Drive parameters to suit individuals and needs, we will only cover the basics in this manual.

1. On/Off button
(press once for On
again once for Off)
2. Horn
3. Mode Button
(select Seating
Functions. Seat
Tilt or Recline)
4. Profile Button (select
Profile - Indoor or
Outdoor drive settings)
5. Speed Button (Sets
speed from Low to
High in 5 stages)
6. Joystick (Used to steer
wheelchair).



More information relating to PG Controller can be viewed at www.glide.com.au
Products – Centro - Centro - Heading Related Documents - PG Manual.



Never push the On/Off button on the Joystick module until you are seated correctly in the chair.

IMPORTANT: Please familiarise yourself with the individual functions of your controller in particular the On\Off button. Once for ON and pressing the same button or pad again for OFF.

1. Do not displace the joystick when pressing the ON button. An error will occur and you will have to turn controller off and then back on again.
2. Always set Speed selection to suit environment. Indoor driving should be set to a lower top speed.
3. Driving on highly polished floors can be slippery. Lower the Speed setting to half or even less if required.
4. Unless in an emergency, never press the On/Off button while driving your powerchair.
5. Never hang items on the joystick. (E.g. shopping bags)
6. To avoid damage to motor gearboxes always come to a complete “stop” before turning your power chair off.

Driving

When driving the wheelchair for the first time you should always start with the slowest speed setting and gradually increase as you get accustomed to your wheelchair. The seat should also be slightly tilted (approx. 8 degrees) for best driving performance. Avoid driving your wheelchair when Seat Tilt is set flat or zero degrees as this may change driving characteristic and may also interfere with ground clearance of foot plates or foot plates interfering with castor wheel.

Armrests

The Flip up armrests are adjustable in height, position forward or aft of arm pad.

These can be permanently set in the desired position and locked with bolts or user adjustable using locking knobs or thumb knobs.

To adjust height, loosen Turn Knob located on outside of armrest Post. When adjustment is complete retighten Turn knob .

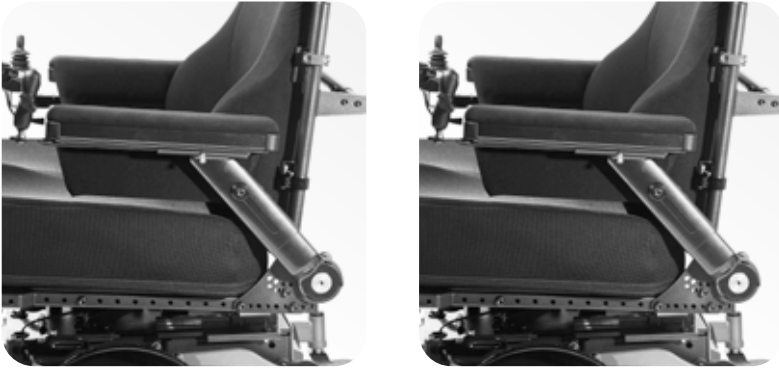

Forward and Back Adjustment of Arm Pad

Loosen small turn knob located on the outside and underneath arm pad.

Re-tighten when adjustment is complete. Do not undo more than one turn.

This knob also allows adjustment of joystick module.

Flip Up Armrest Lock

Located on the inside of the armrest mount bracket. Pull knob out and turn 90 degree.

This will allow armrest to move freely up and down. To lock, turn knob 90 degrees and allow knob to drop in. Drop armrest down and arm should be in the locked position.

Legrests and Footrests

The footrests are swing away and detachable. They swing out by pulling the release lever. When lever is released, the footplate will simply swing out and lift off the two locating Pins.



When refitting footrest to wheelchair ensure that it is located on both locating pins. Damage may result if only one pin is used. Once the legrest is on the locating pins and with foot plates up, swing legrest towards centre of chair firmly so latch will click into position.

Height Adjustment of Footplate

Your footplate will be fitted with one of two types of adjustment styles.

1. Clamp Type—to adjust height simply loosen clamp bolt, move to desired position, retighten clamp bolt.
2. Incremental Hole Type—to adjust height simply un-do and remove bolt, move footplate to nearest hole to suit desired height, replace and tighten bolt firmly.

Drive Disengage/ Engage

Your wheelchair may be fitted with one of two types of Drive disengagement for manually pushing the wheelchair.

- A. Motor Brake disengagement
- B. Clutch Drive Wheel disengagement

! **Before disengaging any Drive on your wheelchair please read the following. The wheelchair will have no braking when Drive is disengaged. Never disengage Drive on a slope as you will have no control of the wheelchair. Only disengage Drive on a horizontal surface.**

Type A - Motor Disengagement.

The motor Brake disengagement Turn Key is located on the front of the each motor as show in image below. Rotate each Key on both motors clockwise (approx. 45 degree) to disengage the Motor Brake. The key will snap into position when disengaging.

Once disengaged, the attendant will be able to manually push the wheelchair. Once completed, re-engage Motor Brake by rotating the Key anti-clock wise until it snaps into position. Never leave the wheelchair disengaged.

You will not be able to drive the wheelchair while either one or two motors Brakes are disengaged. An error will show up on the joystick module as shown in image below. You will need to turn the power OFF, re-engaged Motor Brake and then power up wheelchair again before use.



Type B – Drive Wheel Clutch Disengagement.

The Drive Clutch is located in the centre of each driving wheel. It is identified as a large Black Knob with grip rings.



To ENGAGE, simply turn Black Knob (Drive clutch) in either direction until you here a “click”. Turn chair on and SET AT SLOWEST SPEED and then SLOWLY move joystick forward until drive clutch self engages. When clutch is engaged fully, the outer face of the Drive clutch will be flush with the retainer washer.

To DISENGAGE simply pull out drive clutch and turn 1/8th of turn or 45 degrees to locate clutch in the disengaged resting position. This will allow the chair to be free wheeled. You may need to take some load off the Drive clutch by moving the Drive wheel by hand slightly forwards or backwards at the same time as pulling out Drive clutch.

Brakes

Your power chair has electronic brakes and they are activated in the flowing manner.

1. If chair suffers a power failure while driving
2. When joystick of controller is released
3. When chair is turned Off



Electronic Brake will not work if either Motor Brake or Drive Clutches are disengaged. The electronic brakes are static brakes only and the wheelchair controller will use the motors for slowing the wheelchair before the electronic brakes are automatically activated. In addition the power chair is fitted with Attendant static brakes for use when stationary. These should be used by an attendant when transporting in vehicle or when securing the wheelchair.

Adjusting the Backrest Angle

There are 2 options available for backrest angle adjustment

1. Standard on all Centro's wheelchairs, unless otherwise ordered, is an incrementally adjustable Back Rest canes via Armrest/Back Canes bracket. It is advisable to have a Glide agent or trained Technician to make this adjustment.
2. Electrically operated actuator. These are operated in several ways:
 - Button located on controller in conjunction with joystick.
 - Remote switches located for best access by occupant.
 - Please refer to respective Controller manufactures user guide for more info.

Please familiarize yourself with this function for trouble free operation.

Adjusting the Seat Angle

1. Electrically operated actuator. This is operated in several ways
 - Button located on controller in conjunction with joystick.
 - Remote switches located for best access by occupant
 - Changing to actuator on MODE setting and using joystick to adjust.
 - Please refer to respective Controller manufactures user guide for more info.

Please familiarize yourself with this function for trouble free operation.



User Training & Wheelchair Setup

Before using this wheelchair, you should be fully trained on all aspects and options on this wheelchair by your Health Care Professional in conjunction with the Manufacturers Sell Agent. You should always start in a slow Drive Mode selected on the controller and gradually increased speed as you become more proficient in your driving ability. Maximum speeds should be set to suit user's capabilities.

Setup

It is important the wheelchair is Setup correctly by a Health Professional in conjunction with the Manufactures Selling Agent. Your wheelchair may be fitted with a third party seating systems and may differ from this manual.

Positioning Belts

The use of positioning belts is highly recommended as it will help support the occupant and also prevent occupant from falling. The use of position belts must ONLY be setup by Health Professional. Improper use of positioning belts may cause serious injury.



Positioning belts are not to be used as a seat belt when occupant/wheelchair is transported in vehicle. Please refer to Section 6 Transporting Your Power Chair.

Today, there are many seating systems on the market to fit a multitude of wheelchair types and brands and also to suit individual needs and preference. The Centro has been designed to accommodate many of these systems including Glide's own. Because of the varying nature of these systems and possible changes to the centre of gravity, it will be necessary for a Health Professional with the aid of the Selling Agent representative to insure the wheelchair is set up safely.

Power Seat Tilt

Your wheelchair will more than likely have a 50 degree power seat tilt which is a common recommendation by Health Professionals today.

Whether you tilt your seat to the full extent is entirely your choice but you should be trained in its use and learn to feel safe with this features. The wheelchair will not drive once it has passed 22 degrees and will have to be returned back to a safe level before being able to drive gain. The wheelchair must always be on a level surface when tilting passed the 22 degree mark.

Power reclining Backrest

Your Health professional may have prescribed a power reclining backrest with this wheelchair. The user should be trained for the use of this feature and should feel comfortable with its operation.

Other Options

Your wheelchair may also have other powered operated options fitted to your wheelchair. You must be trained by you Health Care Professional or Selling Agent Representative before using any of these options.

These could included:

- Power Elevating Legrests
- Vertical Lift Raise Seat. (Refer Section 12)
- Power Swing away Chin Control Unit



Before using any power operated option, ensure everyone is clear of wheelchair as pinch points may inflict serious injuries.

Battery Maintenance & Charging

Your Powerchair Battery Charger is specific to your wheelchair and may not be suitable for other Powerchairs.

Only use the charger supplied with your wheelchair. The use of third party chargers may damage or shorten the life of your batteries.

When should I Charge the Batteries

You should charge after use each day. If the Fuel Gauge is in the RED range on the controller you should not drive your wheelchair and must charge immediately. Driving in the RED will damage the batteries. Flashing Fuel Gauge lights is a warning to charge your batteries.

Charging your power chair

1. Ensure charger is switched off and controller is off.
2. Connect charger to wheelchair via the charging socket located on the front of the Joystick module.
3. Turn power On at Charger
4. Ensure the charger is properly connected at both ends and checking status lights on charger.

Charging Operation

Please refer to specific charging operating instructions supplied with your wheelchair.

Charging Duration

Charging times may vary depending on usage or battery state of charge, battery size, battery condition and age of battery. In most cases overnight charging (8 – 10 hours) is sufficient. Avoid driving your wheelchair until batteries are fully charged.

Under charged batteries will reduce your driving range and shorten battery life.

Note: The Fuel Gauge on your controller may state fully charged but may not necessarily be fully charged and could be as low as 75% charged. Only your charger will state when fully charged.

No harm will be done to batteries by leaving them on charge after charging is complete, however prolonged charging is not advisable. eg. 1 day or more days.

Battery Wiring Diagram

If warranted, packing blocks could be used to limit battery movement as batteries come in varying shapes and sizes.

Glide recommends 70 to 80 A/H batteries smaller lighter batteries may change the balance of the wheelchair. Battery weight should not be less than 20kg per battery. Amp/hr rating should be at 5 hours.

When is it time to replace Batteries?

On average, you should get 12 months life from your batteries before the need for replacing. This is a guide only and depends on many factors including proper charging

Each night. As the batteries deteriorate you will notice that the batteries are not lasting as long between charges and eventually you will need to replace as a full charge may only last a couple of hours or less.

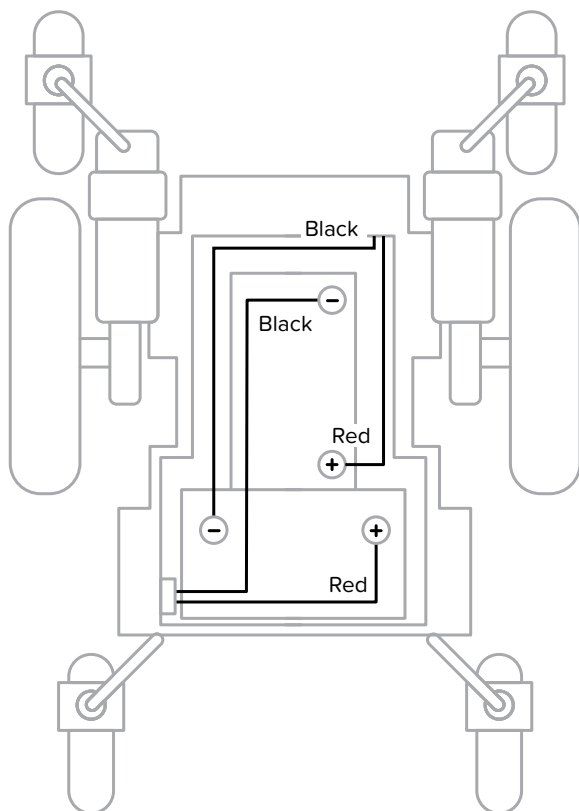

Battery Installation & Removal

Battery installation should be carried out by qualified Technician.

1. Remove footrests and set Seat Tilt to approx. 20 degree. If no batteries installed, discount seat actuator cable from Power module or ISM and using suitable connection cable, connect seat actuator to battery (12v is ok) and operate actuator until seat tilts to 20 degrees.
2. Remove 4 securing bolts holding down Seat Base module.
3. Apply Park Brake and using Back Cane push handles, tilt seat base forward. Remove battery cover and attached security hook as illustrated below.
4. Unscrew and remove circuit breaker.
5. To avoid accidental shorting of batteries when installing, ensure terminal protection caps are installed. If not, then use insulation tape and cover all terminals.
6. Orientate front battery and lift into back of Battery Box and slide forward. Orientate rear battery and lift into battery box. Secure battery using tie down bolts and clamps
7. Connect all wires in accordance to wiring diagram page 23.
8. Once completed, detach security hook and swing hook to back of chair and locate in holder. Insert plastic Battery Cover on top of batteries (ensure correct orientation) and lower Seat Base back down to chassis. Insert 4 bolts into base plate and chassis and tighten nuts.

Please adhere to Battery installation Warnings on page 23.

Note: Vertical Lift seat models (post 2013) will hinge from rear of wheelchair.

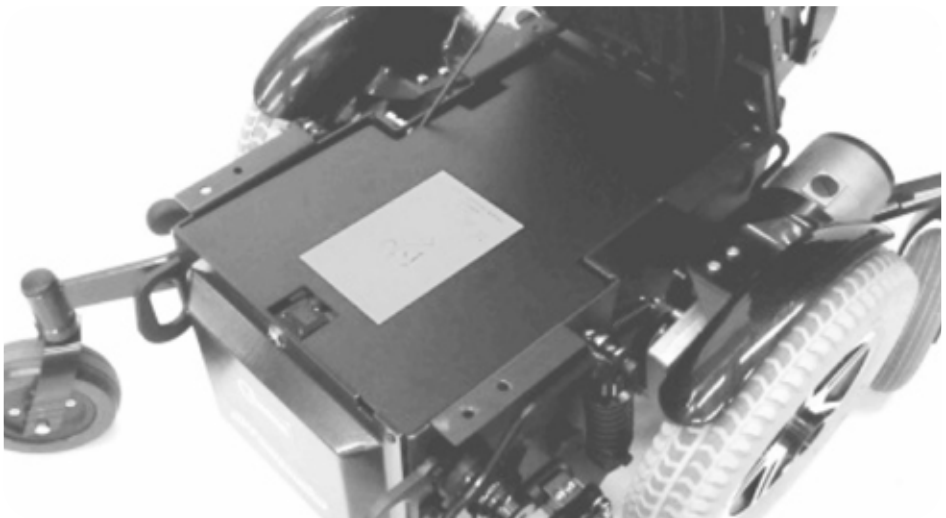



Plastic Installation Cover

The Plastic Insulation cover must be installed at all times as illustrated page 20. Ensure rubber base mat is in place. Ensure battery connectors are secure and Battery Hold Down bolts are tight using Nyloc nuts.



Hinged Seat Base models

Seat Base must only be hinged forward to remove or insert batteries. For your safety, never attempt any other maintenance work to wheelchair other than battery installation whilst Seat Base has been hinged. Damage to hinge may occur.

Battery type and size

Only use batteries with a total combined weight of 40kg or more. Your wheelchair was designed for optimum balance using batteries of this weight. Replacing batteries with smaller or lighter batteries such 50amp/hr batteries may change the balance of the wheelchair.

Recommended Battery Battery Type:

GEL Sealed Lead Acid - Deep Cycle
2 x 12v 75amp/hr approx weight each 24kg.

Maximum Battery dimension:

260L x 171W x 220H.

*Do not use batteries weighing
less than 20kg each.*



Note: For installation, please refer to battery wiring diagram page 22.

The plastic insulating Battery Cover must be in position before securing Seat Base module to chassis. Never leave out the plastic insulating cover plate as electrical short or fire could occur if batteries become dislodged.

If you believe your batteries are not properly secured or have come loose over time, cease driving your wheelchair and have it checked by a service technician. Consult your Glide Agent if battery replacement is required.

Routine and Scheduled Cleaning

The Centro power wheelchair has been design for minimal service requirements and will give years of service if used correctly.

Daily

Charge your batteries every night so your Powerchair is ready to go when you are. Check first up each day that your chair drives as it should. If your wheelchair suddenly drives or reacts differently, it generally means something is wrong and you should cease using the wheelchair until it has been check by a Technician. It could be something as simple as a flat tyre or it could be something more serious.

Weekly

1. Check tyre pressures and tyre wear or damage.
Recommended pressure
Front castor 206 kpa or 30 psi
Mid Drive wheel 206 kPa
Rear castor 206 kpa
These pressures can be reduced slightly for a softer ride.



Never use High Pressure inflators such as Service Station guns unless regulated. These are fast flowing guns and could result in over inflation or explode the tyre. Only use regulated air guns or hand pump.

2. Clean frame and vinyl parts with mild soapy solution.
3. Wipe upholstery with a clean damp cloth
4. Check all cables for possible damage and ensure all connectors are secured; i.e. battery, motors and controller.
5. Check both front and rear castors for any excessive movement about the top or bottom bearing mounts or pintle shaft. Contact your nearest Glide Products agent for repair of this fault if it occurs.
6. Check function of electric brakes (When chair is turned on with motors engaged and hand off the joystick, you should not be able to push the chair or rotate the drive wheels) If wheelchair can be moved, do not operate wheelchair and get a service technician to rectify immediately.

Monthly

1. Give the chair a general inspection for loose nuts and bolts or any damage.
2. Check attendant park brake is operating correctly.

Six Monthly

Extreme users should have the two front suspension pivot points greased every six months. There are two grease nipples clearly visible on the end of the pivot shaft. Otherwise annually will be sufficient.

Annually

It is advisable to have an annual inspection of the Power Chair performed by an authorised Glide Products Agent. Their knowledge and experience enables them to identify and correct problems that might otherwise go undetected.

For any questions concerning procedures or service, contact your nearest Glide Products selling Agent or Glide Products Direct.

There are two different sizes of stops:

Type A 37mm - for Anterior Tilt or 0 degree rake.

Type B 45mm - 4 degree seat rake

Vertical Lift wheelchairs do not require this stop.

User Serviceable Parts

The only user serviceable parts are as per Section 14 and 15.

For safety, all other components are to be serviced by Glide Products or a trained Technician.

Cleaning Wheelchair and parts

Cleaning should be carried out regularly using a mild soapy solution for all painted surfaces and a damp cloth for all other areas. Always dry off with a clean cloth. Upholstery can be cleaned with a mild detergent and then wiped again with a damp cloth using water only. Leave in an area where it will dry.

Recommended grease type:

Molybdenum disulphide 3%. Brand: Valvoline - Valplex M Grease or similar.



Using a High-Pressure Water Cleaner.

Glide does not recommend using high pressure cleaners but does concede that on rare occasion it may be necessary. Before proceeding, all Electrical components including controllers must be removed from wheelchair before using high pressure guns. Motors must be tightly sealed with a plastic cover and never aim gun directly at the motors or gearbox. Never use alkaline based solvents or degreaser as they are highly corrosive. All 4 suspension pivot points should be regreased using a Molybdenum base grease after high pressure cleaning.

Packing & Shipping

The Centro Power Chair is shipped to Glide Products agents on a pallet enclosed with a cardboard box to minimise damage during transport. Your chair should arrive to you fully assembled and ready to use. If your chair needs to be transported interstate or overseas, it is recommended that a shipping box and pallet be used. These can be purchased from your nearest Glide Products agent or dealer.

NOTE: *As stated in our warranty, we recommend that your wheelchair be returned to a Glide Products agent for its free 3 month safety check. This is a one off free service calculated from date of purchase.*

Loss of Movement

If your Powerchair will not go, follow this checklist:

1. Check that the lights on control Joystick are illuminated.
2. If there are no lights on controller, check that all leads/plugs, which connect to controller, are pushed in and secure.
3. Check for damaged cables.
4. Check that the motor cables are properly connected.
5. Check all battery wiring is connected.
6. Check circuit breaker located at rear left of the wheelchair and reset. The circuit breaker will trip when the wheelchair is stalled for a prolonged period or if a major fault has occurred. If circuit breaker continually trips for no apparent reason, cease use and contact nearest Glide service agent.
7. Important: Allow 60 seconds before resetting circuit breaker.
8. If you still have problems after reviewing the above checklist, please contact your nearest Glide Agent or Glide Products direct.

Wheelchair Speed Suddenly Reduced

The wheelchair controller has built in safety features to reduce damage to the controller and motors. In the event your wheelchair suddenly reduces speed, it may be because over heating of the controller. This could happen going up a long steep hill or if been continually in a stalled situation. Give the wheelchair time to cool and try again. If the problem persists, then contact your Glide selling Agent.

If Smart Drive Encoders are fitted and a problem is detected by the controller then the wheelchair speed will be reduced by 50% (get you home mode). It will be safe to continue to drive but all functionality of the encoder will cease to operate until rectified.

Encoders are mounted on front of each motor. Check cables for damage or possible disconnection.

If you are unable to rectify then the issue must be addressed with a service Technician at your earliest convenience.

Controller Precaution

The PG and Dynamic controllers have been designed with user safety as the prime consideration. They incorporate many, sophisticated self – test features which search for potential problems. If the controller detects a problem either in its own circuits, or in the wheelchairs electrical system, it may decide to halt the wheelchair depending on the severity of the fault. The controllers are designed to maximise the user safety under all normal conditions.

In spite of their sophistication, the controllers cannot take into account, circumstances, which put the wheelchair or controller outside their specified operating conditions, and so it is important that the user follows the following precautions.

1. Do not Drive the wheelchair:

- If the controller is damaged or other crucial components are known to require repair.
- Visible signs of Electrical cable damage.
- If Joystick shows any signs of damage.
- Beyond restrictions indicated in the user manual.
- In places or on surfaces where a loss of wheel grip could be hazardous, for example wet or wet grassy surfaces.
- In the event of the wheelchair moving in an unexpected manner, release the joystick. This action will stop the wheelchair under any circumstances.
- If your wheelchair is not steering or not performing normally or is making strange noises or knocking sounds cease driving the wheelchair immediately and have a Service Technician examine your wheelchair.

2. Although the controllers are designed and manufactured to be extremely reliable and each unit rigorously tested, possibility of a system malfunction always exists (however small the probability). Under some conditions of detected system malfunction, the controller must (for safety reasons) stop the chair instantaneously. If the physical impairments of the user are such that a sudden braking action could result in a fall from the chair, it is advised that a restraining device be fitted.

3. It is recommended that a restraining device be used when operating the Power Chair.

Replacing or Servicing Controllers



Never swap Controller parts from another wheelchair. All replacement Power Modules will need re-programing by Qualified service Technician before use. If this is not done then Damage to motors may occur.

The controller supplied with your wheelchair is *specific to your wheelchair ONLY* and has been programmed to suit wheelchair model and motor type attached to that wheelchair. Under no circumstances should your controller be swapped with another controller from another wheelchair without the strict guidance from your supplier. Doing so may cause the wheelchair to drive erratically and in a dangerous manner. All servicing and programming of controllers must be carried out by Selling Agent or trained Technician. If your wheelchair handles poorly after servicing it may be an indication that the wheelchair has been re-programmed incorrectly and should not be used until rectified.

Warning: PG Controls and Dynamic Controls accept no liability for losses of any kind arising from unexpected stopping of the wheelchair or improper programming of the controller or improper use of the wheelchair or controller.

Transferring In & Out

The Glide Rehabilitation Products Power Chair is designed in such a way that transferring in and out can be done with a minimum of fuss.

1. Make sure that your chair is turned off before transferring.
2. Ensure your wheelchair attendant brakes are applied.
3. Armrests can flip back allowing easy lateral movement from either side of chair or for the fitting of a patient hoist sling.
4. If occupant is ambulant, or able to do standing transfers, removing swing away footplates will allow better placement of feet when standing or conversely, closer access to seat when transferring into chair. Where possible have someone assist you during the transfer.
5. You will need to learn safe transfer techniques from your Health Professional.
6. Always have wheelchair as close as possible to chair that you are transferring to.
7. Ensure that the front castors are facing forward when transferring.
8. If your chair is fitted with Power Operated Seat Tilt or Recline functions, ensure that they are in the down and upright position before attempting to transfer.

SECTION 11 | VERTICAL LIFT MODEL

Vertical Lift

Max Recommended User Weight = 175kg

! The Vertical Lift function has crush points and must be used with extreme care at all times.

Before using any of the functions of the Vertical Lift chair please ensure you have read this section and have been fully instructed and trained on how to use either by your Health Care Professional or a Glide Selling Agent Representative.

The Vertical Lift version is very similar in operation to the standard Centro but has the added advantage of a 300mm vertical lift. This is ideal where users are in environments where constant change in seat heights are required such as the work place or for home use.



! Before operating any function of the Vertical lift, ensure everyone is well clear of the wheelchair and notify persons within your vicinity of your intention before raising or lowering the lift. Never operate if small children are present.

Raise on Level Plane

Only raise vertical lift on firm level ground. For safety, the wheelchair has been programmed for reduced speed once the lift has been raised from the bottom position. Also, once the seat has been tilted approximately 15 degrees the chair will not drive. The seat must be tilted back below 15 degrees before the chair will drive again.

CentroGlide Bariatric Warranty

Lendal Pty Ltd (trading as Glide Rehabilitation Products) warrants the following as listed:

Controllers/Battery Charger - 12 months warranty

Controllers and associated hardware will be repaired where possible.
Replacement will only occur if repair is not practical or not possible.

Motors/Gearbox - 12 months warranty.

Automatic replacement within six months of purchase. There afterwards, unit must be returned for evaluation and possible repair before replacement.

Actuators - 12 months warranty.

Chassis - 5 + 5 year warranty.

Chassis will be replaced within the first five year period. Thereafter, Glide will extend the warrant for further five years and will either repair or replace.

Upholstery - 6 month warranty

This will cover against defects in materials or workmanship.
Warranty does not cover against normal wear or damage.

Tyres and Tubes - No Warranty

Spare Parts - All spare parts sold will have a 6 months warranty period from date of purchase.

This warranty does not extend to parts or electrical components damaged by misuse, neglect, accident or improper installation, nor those tampered with, altered or serviced by an agency not authorised by Lendal Pty Ltd. Any incorrect programming of wheelchair by Third Party will also void warranty.

User Serviceable Parts

Replacement TYRES

8" (200*50) Pneumatic Front 8"	Part Number – 202602
8" (200*8) Foam Filled Front (split rim only)	Part Number – 202602A-F
14" Pneumatic (300-8) Drive Wheel	Part Number – 202672
14" Foam Filled (300-8) Drive wheel	Part Number – 202672-F
7" Castor tyre rear (pneumatic)	Part Number – 202603
7" Castor tyre rear (foam filled)	Part Number – 202603A-F

Replacement TUBES

7" (7*1-3/4) Rear (split Aluminium rim)	Part Number – 202493
8" (200*50) Front (split Aluminium rim)	Part Number – 202492-SA
300-8 Drive wheel 14"	Part Number – 202565

Replacement CASTOR WHEEL COMPLETE WITH TYRE AND BEARINGS

6" Castor Wheel rear (plastic Hub)	Part Number – 310130
7" Castor Wheel rear foam filled	Part Number – 20120A-F
7" Castor Wheel rear pneumatic	Part Number – 20120A
8" (200*50) Castor Wheel front pneumatic 8"	Part Number – 20121A
8" (200*50) Castor Wheel front foam filled 8"	Part Number – 20121A-F

For more specific spare parts, view our web page www.glide.com.au.

Find this information under Spare Parts, Centro.

SECTION 14 | PUNCTURE REPAIR

Replacing Inner Tube on Mid Drive Wheel

Raise wheelchair 25mm to 50mm from the ground so the wheel can be removed. Using a 13mm socket spanner, remove Nyloc Nut and retainer washer from centre of wheel as per Fig 1 below and remove wheel from the wheelchair.



Fig. 1

Using a 3/16th socket key, undo all 8 bolts as per **Fig 2** below. Before undoing Hex screws, ensure tyre is deflated. When all screws have been removed, remove rim half away from the wheel **Fig 3**. The inner tube will now be exposed for re-fitment of new inner tube. Slightly inflate the tube and insert into tyre.

To re-assemble, replace tyre on the front side of the rim and line valve up with indentation on rim as arrowed in **Fig 3**. Make sure the tyre is seated correctly and then insert back half of rim on the wheel as per **Fig 2**. Again make sure the indentation on the back rim lines up with the valve. You can now gradually re-tighten all 8 screws. All screws need to have a thread locking compound (**Loctite 277™**) or equivalent.

Do not tighten each screw in one operation. Instead, gradually tighten opposing screws evenly as you go. When all screws are tight you can inflate tyre to the correct pressure.

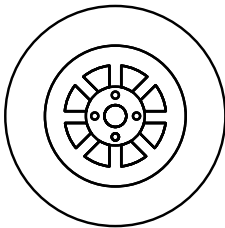

Fig. 2

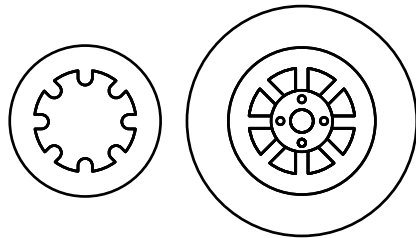



Fig. 4

The wheel is now ready to be replaced back on the wheelchair. Before inserting on gearbox shaft, clean shaft with a cloth and slightly grease the shaft. Insert 5mm Key onto gearbox shaft and line hub keyway up with shaft key and slide wheel back on. Re-install the retainer washer and Nyloc Nut to shaft and tighten nut to 50 nm torque. It is recommend a new nut be used each time.

 Once installation is complete, test drive wheelchair by Stopping/ Starting and turning several times to ensure it drives correctly.

Replacing Inner Tube on Castor Wheel

Raise wheelchair so Castor wheel is 25mm to 50mm from the ground so the wheel can be removed from castor fork. Using two ring spanners 13mm remove wheel bolt from castor fork. Remove wheel (make sure tyre is deflated) and then remove 4 nuts on wheel as per **Fig 6**. Once all 4 bolts have been removed you can remove one half of the hub which will leave the tyre and tube exposed **Fig 7**. Remove old tube and replace with new tube. Slightly inflate the tube before inserting new tube into tyre. Re-fit tyre/tube back onto one side of the hub as per **Fig 7** ensuring you line the valve up with valve hole on hub. Make sure tyre is seated correctly and then fit other half of the hub, again ensuring the hub valve indentation lines up with the valve. Replace all 4 bolts (inserting bolts from valve side of hub) as per **Fig 6** and tighten Dome nuts. Replace wheel back onto fork and tighten bolt. Do not over tighten. Make sure wheel spins freely.

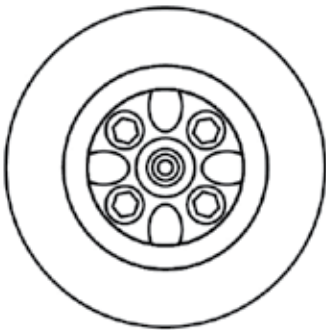

Fig. 6

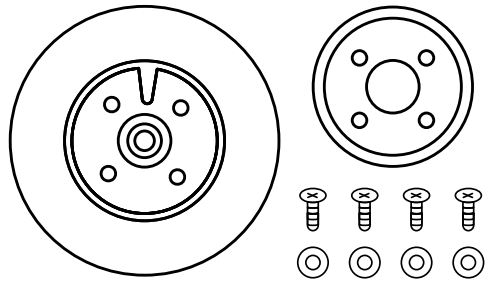
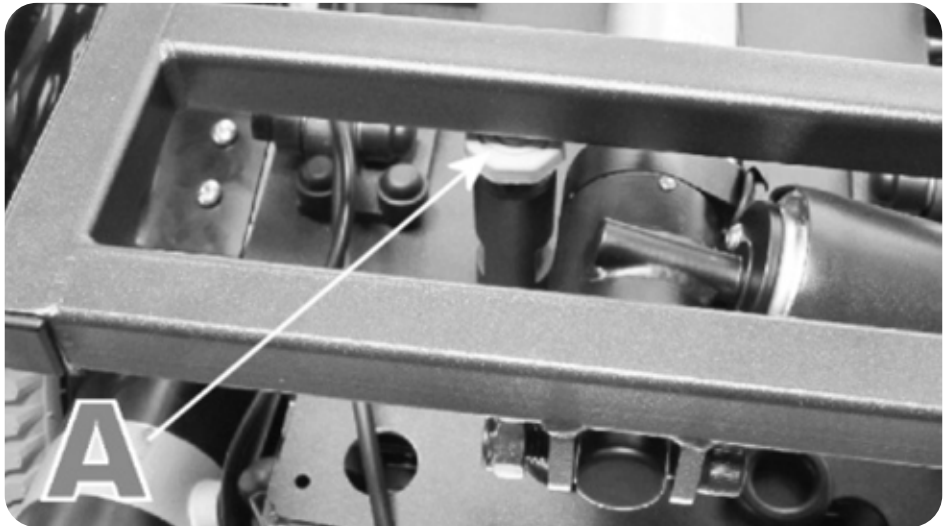

Fig. 7

Seat Frame stop

! The Seat Frame Stop is a safety stop only and is factory set to the correct height. If adjustment is required, then the following procedure must be followed.

Firstly the Tilt seat actuator must be set in the bottomed (least tilt) position and then the adjuster set so it is just short of the seat frame by 1 to 2mm. The stop must not be used as actuator limit stop. Damage to the actuator or seat frame will occur.



Wheeled mobility devices for use as Seats in a Motor Vehicle.

Wheeled mobility devices for use as seats in a Motor Vehicle.

In accordance to AS3696.19

Applicable to:

Centro

Centro - VL

Centro - Bariatric.

Table of Contents

Safety Warning	39
Overview	40
Determining Motor Vehicle Size and type.	41
Maximum User weight and Wheelchair Mass.	42
Wheelchair Securement in vehicle	43
Wheelchair setup for Transport.	45
Occupant Restraint setup.	46
Postural Support Devices	48
Non Tested Backrest and Seating systems.	49



It is safer to be seated in the OEM vehicle seat using the OEM restraint system than seated in a wheelchair using the approved restraint systems.

For this reason, where feasible, wheelchair users should transfer to the vehicle manufactured installed seat using the (OEM) restraint system.

Unoccupied wheelchair should be stored in the cargo area and secured during travel.

1. Wheelchair users should transfer to the vehicle seat and use the vehicle-manufacturer-installed restraint systems whenever it is feasible, and the unoccupied wheelchair should be stored in a cargo area or secured in the vehicle during travel.
2. The Centro complies with AS/NZS 3696.19 and has been tested for use in a forward facing position ONLY.
3. The user must not weigh more than 159kg for Centro and Centro VL and Centro Bariatric.
4. When wheelchair is used as Occupant Transport the wheelchair must be in the forward facing position.
5. Use a 4 point strap type wheelchair tie-down. This could be a hook attached to the Tiedown strap end or if no fitting is supplied loop the Tiedown webbing through the securement point to the tiedown. (refer standards below)
6. Use a Three-point-belt restraint comprising a pelvic-belt restraint and a shoulder-belt restraint that connect together near the hip of the occupant.
7. Only use the designated Tie-down points located on wheelchair. Two front, two rear. (Fig. 2)
8. Use only WTORS (Wheelchair Tie-down and Occupant Restraint System) that complies and installed to the requirements of ISO 10542-2 or ADR 4/04 or AS/NZS 2596 or equivalent.

Overview.

Crash Test

The Centro VL model with optional Power Recline was chosen as our test model, being the heaviest of all the Centro models.

The Centro was dynamically test in a forward facing test with ATD (test dummy) using a 4 point wheelchair tie-down system and a three-point-belt restraint comprising a pelvic-belt restraint and a shoulder-belt restraint that connect together near the hip of the occupant. A Lap or Hip Belt connected to the wheelchair was also used.

The Centro was tested in accordance to 3696.19 using a test dummy of 102kg. This represents a large Adult Male representing a user weight greater than 136kg to a maximum of 159kg.

Determining Motor Vehicle Size and type.

The size and type of wheelchair will impact on the type of vehicle suitable for Wheelchair Occupant transport. Smaller vehicles are generally not suitable for Occupant Transport of powered wheelchairs. The Centro is a mid-wheel drive chair and has good manoeuvrability inside a vehicle. Vehicles with rear entry are the preferred vehicle type.

Best practise for positioning the wheelchair in a vehicle in a Forward Facing position is to drive straight in from the rear of the vehicle and avoid manoeuvring inside vehicle where possible. To unload wheelchair, again the best practise is to reverse wheelchair straight out without manoeuvring inside the vehicle.



Never manoeuvre wheelchair while wheelchair is on a ramp or lifting ramp.

Occupant Vehicle Transport Maximum User weight

Centro = 159kg
Centro - VL = 159kg
Centro - Bariatric = 159kg

Score rating of proper placement of vehicle-anchored belt

Good. 15/16.

Wheelchair Mass

The mass weight of the Centro wheelchair can vary depending on options fitted.

Below is a typical operational weight with 90 Amp/hr batteries fitted.

Centro with Power Recline = **140kg**
Centro - Bariatric with Power Recline = **142kg**
Centro - VL with Power Recline = **165kg**

Wheelchair Securement

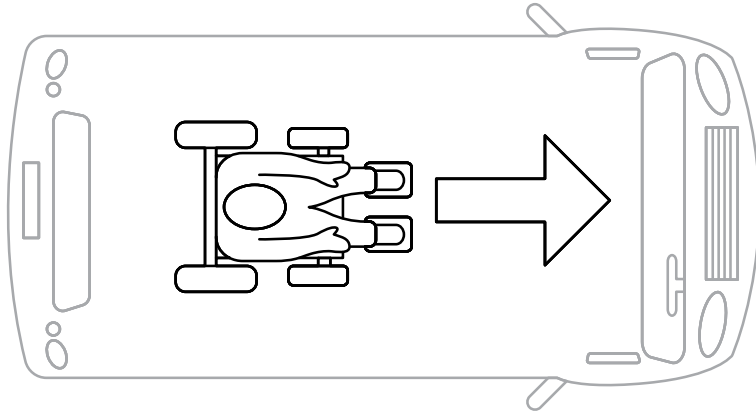

Fig 1.

The securement of the wheelchair must be in a forward-facing position in a motor vehicle.

The Centro uses a Four Point Strap –Type Tie-down system

The Tie-down system used must comply with ISO 10542-2. This will consist of two Front and two Rear attachment point and occupant restraint belts. The systems must be fitted and used in accordance with the manufactures instruction along with the wheelchair manufacturer instructions.

Wheelchair Tie-down location



Only use the designated Tie-down points on the wheelchair. (Fig. 2).
Never be tempted to use any other point for attachment.

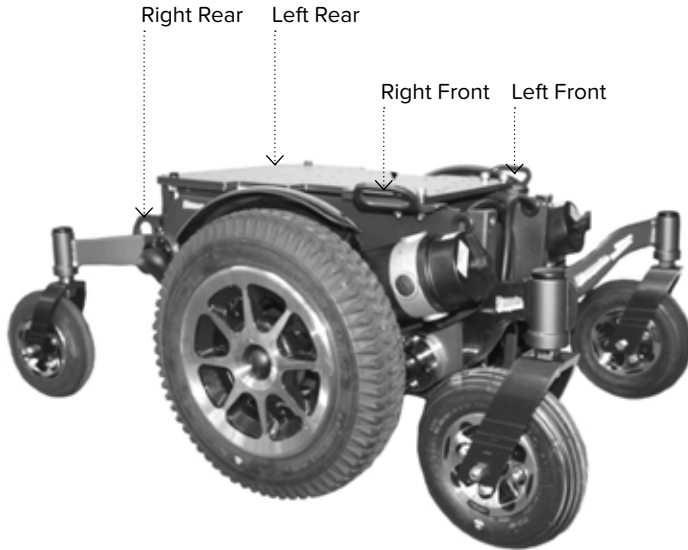

(Fig. 2)

Each Tie-down attachment point on the wheelchair will be labelled with the Hook symbol (below).

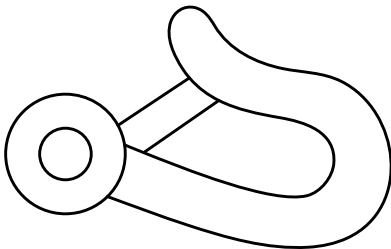

Wheelchair Tie-down location

1. The Seat Tilt must be in the lowest down position.
2. The Back recline must be in the furthest upright position.
3. Head rest should be adjusted within 50mm of the back of the occupants head and the centre of the head restraint being at least as high as the rearward point on the back of the head during normal travel.
4. Foot plates must have a minimum ground clearance of 80mm for Standard Centro and 100mm for all VL models.
5. Both Shoulder and Pelvic belts must be used to reduce possibility of head and chest impacts with vehicle components.
6. Postural Supports should not be relied on as occupant restraint unless identified as complying to ISO 7176-19 or AS/NZS 10542.1
7. Tire pressure should be at recommend pressures.
8. Motor Brakes ON or Drive Wheel Clutches engaged.
9. Manual Park Brakes ON.
10. Remove trays and secure in a separate section of the vehicle or trays can remain secured to wheelchair positioned out of the way from occupant with energy absorbing padding between tray and occupant.
11. Remove all Auxiliary equipment not bolted to wheelchair during transport and secure in a separate section of the vehicle.
12. Use ONLY gel cell sealed batteries.
13. Alterations should not be made to secure points or structural frame of wheelchair without consulting manufacturer.
14. Care should be taken when positioning occupant restraint buckle so it is not contacted by wheelchair during crash.
15. Wheelchair should be inspected by manufacturer should it be involved in a collision.

Occupant Restraints



Only use a three-point-belt restraint which complies to **ISO 10542-2**, comprising a pelvic-belt restraint and a shoulder-belt restraint that connect together near the hip of the occupant.

Belt restraints should make full contact with shoulder, chest and pelvis and the pelvic belts should be positioned low on the pelvis near the thigh-abdominal junction. The shoulder belt should fit over the mid shoulder. (Fig. 3) Belts should be adjusted tightly as possible consistent with user comfort. Belts should not be twisted.

Illustration of proper belt-restraint fit.

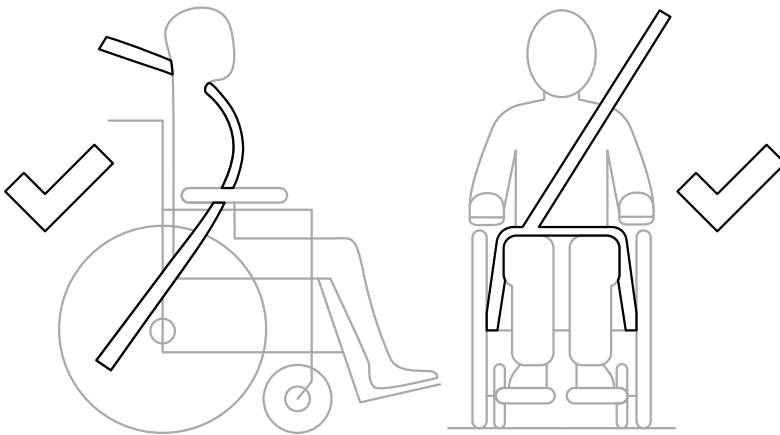

(Fig. 4)

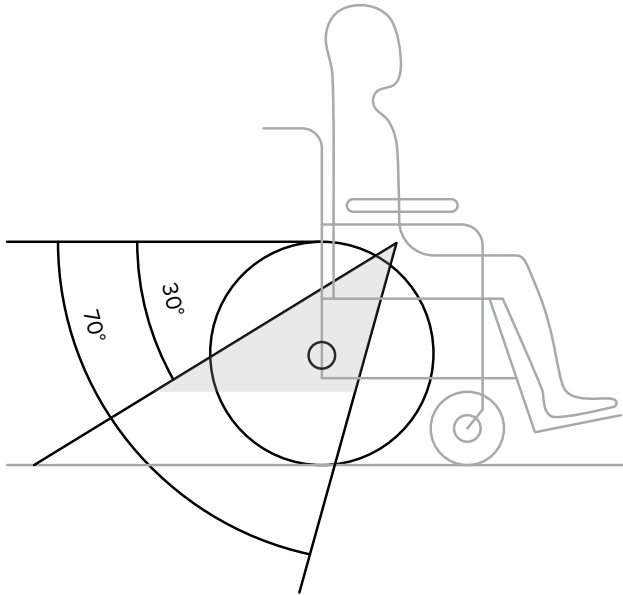

(Fig. 4)

Fixing angle of the lap belt is between 30° and 75° to the horizontal, as indicated (Fig. 4). A steeper angle within the preferred zone is desirable. The use of a postural Hip Belt (Lap Belt) attached to the wheelchair is recommended only in conjunction with the Three Point Belt restraint. The Hip belt is not to be relied on as restraint.



Illustration of improper belt-restraint fit.

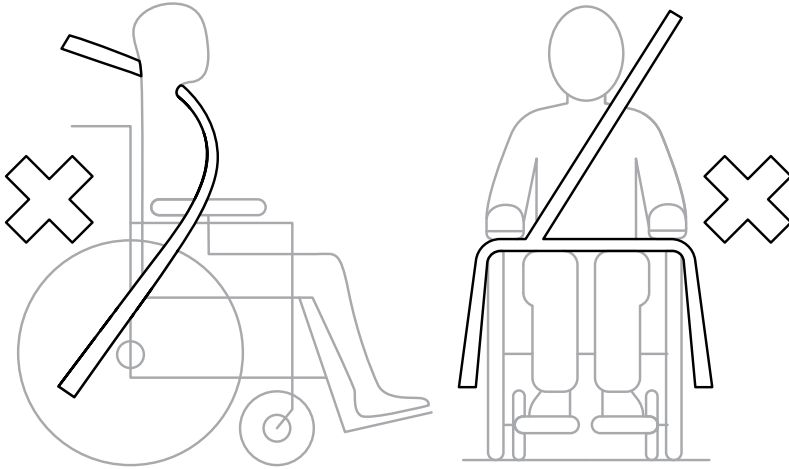

Belt restraints must not be held away from the body by wheelchair components such as armrests or wheels

Postural Support Devices

During transportation, postural support devices where practical, should be removed where they may cause injury during an accident. Postural support devices should not be removed if the client's safety is likely to be compromised during normal transport. It is recognized that in many cases postural support devices provide support during normal vehicle manoeuvres. Postural supports should not be relied on as occupant restraint unless complying with AS/NZS 10542.2 or ADR 4/04 or AS/NZS 2596 or equivalent.

Non Tested Seating /Backrest

Where a seating system is provided for a wheelchair that was not included as part of the wheelchair during the AS/NZS 3696.19 crash test, the following considerations should be made with regard to the selection and application of the wheelchair seating requirements.

- (a) Seating components not provided with the wheelchair for test under AS/NZS 3696.19 should be as light as possible consistent with clinical function and secured to the wheelchair.
- (b) A backrest that reaches to shoulder height.
- (c) A substantial headrest or head support.
- (d) The minimum restraint requirement recommended is a three-point belt restraint.
- (e) Ensure compliance with Clause 6 of AS 3696.10.
- (f) Seating systems that are not part of the wheelchair supplied by the wheelchair manufacturer should be attached to the wheelchair frame without having to drill, weld or glue the fixture to the frame.
- (g) Back support angle during travel should be not greater than 30° to the vertical. It is recognized that there may be instances where this may not be practical.
- (h) Seat reference plane during travel should be greater than 0° to the horizontal. It is recognized that there may be instances where this may not be practical.



Power Reclining back

In reference to (g) and (h) of this section, if the wheelchair is fitted with a Power Reclining back, the Back recline must be in the furthest upright position when transporting. The seat tilt must also be in the furthest down position. (least amount of tilt)

The foregoing in lieu of all other warranties expressed, implied or statutory, Lendal Pty Ltd's sole liability shall be to repair or replace parts of components as specified in Section 13.

IMPORTANT

1. Lendal Pty Ltd (trading as Glide Rehabilitation Products) does not warrant either expressly or impliedly the suitability of the Glide Centro electric wheelchair for the purchaser or any intended user. Purchasers and intended users are advised that advice from an appropriate registered medical practitioner should be obtained prior to using an electric wheelchair.
2. Except insofar as is prohibited by statute, Lendal Pty Ltd shall not be responsible for damage, injury or loss of any kind to any property or person howsoever caused arising from or in connection with the Glide Centro. All conditions and warranties that (but for this provision) would be implied in favour of, and all rights and remedies that (but for this provision) would be conferred upon the purchaser or other persons against Lendal Pty Ltd arising under or as a result of the Trade Practices Act 1974, any other legislation or the general law are excluded and limited to the maximum extent possible and in cases where Lendal Pty Ltd's liability cannot be completely excluded but may be limited, the liability of Lendal Pty Ltd is limited to one of the following (at the option of Lendal Pty Ltd)
 - (a) The replacement of the Glide Centro or the supply of an equivalent wheelchair
 - (b) The repair of the Glide Centre
 - (c) The payment of the cost of replacing the Glide Centro or of acquiring an equivalent wheelchair
 - (d) The payment of the cost of having the Glide Centro repaired



25 Ledger Rd Balcatta
Western Australia 6021
Phone: +61 8 9345 3400
Web: www.glide.com.au

Glide Products Pty Ltd

ABN: 28 645 050 255

ACN: 645 050 255

ISO 9001 ACCREDITED