

Whitmyer S.O.F.T



OCCIPITAL & SUB-OCCIPITAL SUPPORT SOLUTIONS

Distributed by
medifab

SCRIPTING AND ORDERING GUIDE

March 2024

STEP 1: Select Base Plate Assembly Adjustment

<p>Single</p> <p>Single Sub-Occipital Base Plate Assembly Adjustment</p> <p>1480-4942-100</p>					
<p>Dual</p> <p>Adult & Padiatric Base Plate Assembly Adjustment</p> <p>1480-4941-100</p>					

STEP 2: Select Occipital Pad

<p>Adult</p> <p>1480-4613-281</p>				
<p>Padiatric</p> <p>1480-4612-281</p>				
<p>Infant</p> <p>1481-INFT100</p>				

STEP 3: Select Sub-Occipital Pad









Single Pads

Large					
1480-4609-281		4-1/2"	3-1/2" 7-1/2"	3" 9" 1-1/2"	1"
Small					
1480-4610-281		3-1/2"	3-1/2" 5-1/2"	2" 8-1/2" 1"	1"

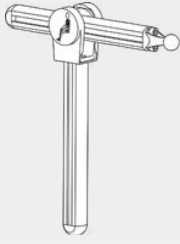
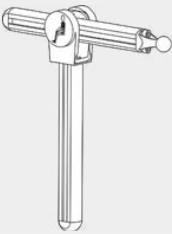

Dual Pads

Size 1					
Left	1480-4601-281	4-1/4"	8" 3-3/4" to 8" 3"	3" 2"	1"
Right	1480-4602-281				
Size 2					
Left	1480-4603-281	4-1/4"	4" 3-3/4" to 8"	3" 1-1/2"	1"
Right	1480-4604-281				
Size 3					
Left	1480-4605-281	4-1/4"	7" 3-1/2" to 7" 2"	2-1/2" 1-1/4"	1"
Right	1480-4606-281				
Size 4					
Left	1480-4607-281	4-1/4"	4" 3-1/2" to 7"	2-1/2" 1-1/4"	1"
Right	1480-4608-281				

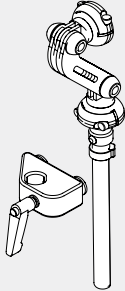
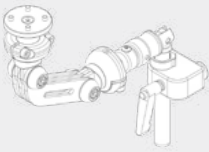
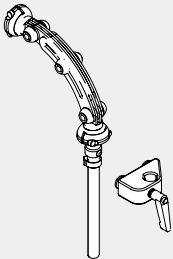
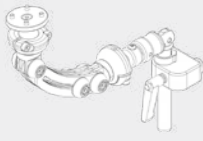
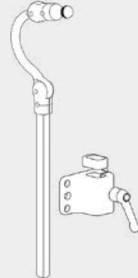
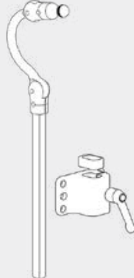
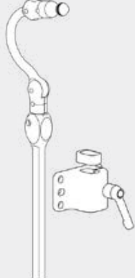
STEP 4: Select Hardware System



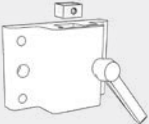

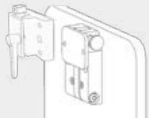
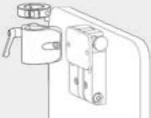
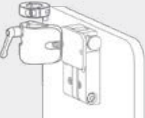



					
Axys	Linx 4"	Linx 8"	Linx 10"	Linx 15"	Pro Paediatric
1480-4913-100	1480-4961-004	1480-4961-008	1480-4961-010	1480-4961-015	1480-4934-101
					
Pro Adult	Linx2 4"	Linx2 8"	Linx2 10"	Linx2 15"	Stylo 160
1480-4934-100	1480-4962-004	1480-4962-008	1480-4962-010	1480-4962-015	1274-1252-500
					
Stylo Flipback 160	Stylo 260	Stylo Flipback 260	Cobra Xtra Paediatric	Cobra Xtra Adult	Cobra Xtra Flipback
1274-2252-500	1274-1282-500	1274-2282-500	1480-4923-102	1480-4923-103	1480-4922-100

STEP 5: Select Mount Bracket

	AXYS	LINX / LINX2	PRO	COBRA	STYLO
Detachable	 1480-4911-100	 1481-M2300	 1480-4931-100	Cobra Xtra Hardware System includes detachable mounting bracket.	Stylo Hardware Systems include a detachable mounting bracket.
Swing-Away	 M5000	 M5000	 M5000		

Lateral Facial Support



STEP 1: Select Facial Pad

FACIAL PADS							
							
Spot	Standard	Long	Curved	Oval	Large-C	Med-C	Small-C
1481-PL10L	1481-PL15L	1481-PL20L	1480-4612-281	1480-4613-281	1481-PL30L	1481-PL35L	1481-PL40L

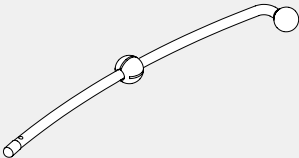
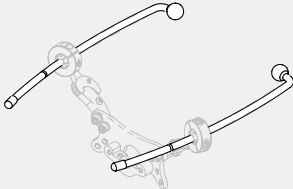
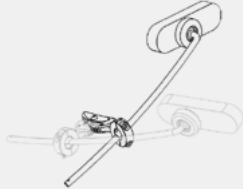
STEP 2: Select Stem

STEMS		
		
Unilateral	Bilateral	Anterior
1481-LM1010	1481-LM1010 x 2	1481-LM1096

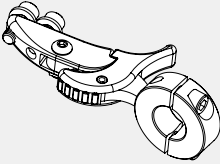
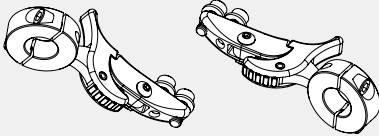
STEP 3: Select Mount

UNILATERAL	BILATERAL	ONE PER SIDE
		
Swing-Away Mount	Swing-Away Mount	Infinity
1481-LM115	1481-LM115 x 2	1481-242161

NOTE: S.O.F.T. headrest comes with the plate to mount the lateral facial pads onto.

STEP 4: Select Anterior Support (Optional)

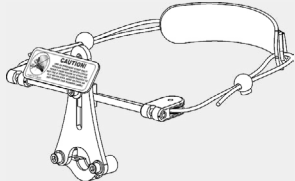
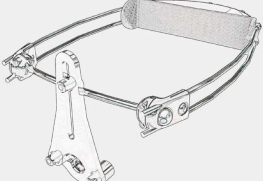
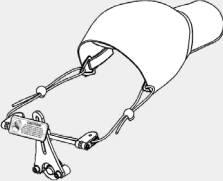
ADULT		
		
Dynamic Forehead Strap	Dynamic Forehead Strap Rigid	Strap Cap (Black)
1480-4822-000	1480-4832-000	1480-4842-099

PAEDIATRIC			
			
Dynamic Forehead Strap	Dynamic Forehead Strap Rigid	Strap Cap (Red)	Strap Cap (Blue)
1480-4821-000	1480-4831-000	1480-4841-020	1480-4841-060

medifab

Distributed by Medifab Ltd

solutions@medifab.com

medifab.com



DISTRIBUTED BY:

Script: Whitmyer S.O.F.T_20240325