

Heads Up



HEAD & NECK SUPPORT SOLUTIONS

Distributed by **medifab**[®]

SCRIPTING AND ORDERING GUIDE

Heads Up Ordering Guide

STEP 1: Select Pad

A) NECK WIDTH

Infant (2.8")	Small (3.5")	Medium (4.1")	Large (5.3")	
I_ _ _ _	S_ _ _ _	M_ _ _ _	L_ _ _ _	

B) PAD HEIGHT

Tall		Short	
_ T _ _ _		_ S _ _ _	

C) SWING-OUT SUPPORT ARM LENGTH

Short	Long		Arm Length Guide		
			Infant & Small	Medium & Large	
_ _ S _ _	_ _ L _ _		Short	5.6"	7"
			Long	7.3"	9"

D) FOAM TYPE

Comfort	Foam Thickness Guide				
	Infant	Small	Medium	Large	
_ _ _ C _	Comfort	0.6"	0.6"	0.8"	0.9"

E) COVER MATERIAL









Lycra	
_ _ _ _ L	

BUILD CODE FOR STEP 1



Fill codes of selected options from **SUB-STEP** A, B, C, D, E of **STEP 1** in sequence.

NOTE: Chin Piece is included

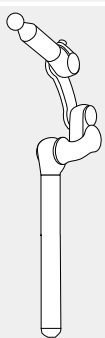
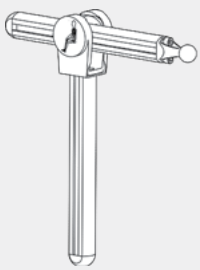
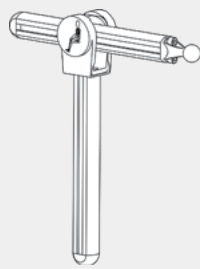
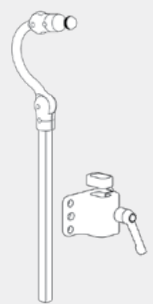
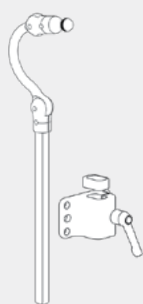
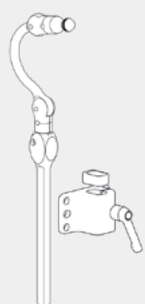
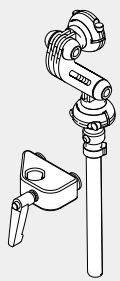
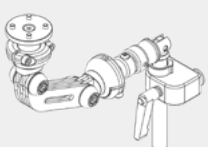
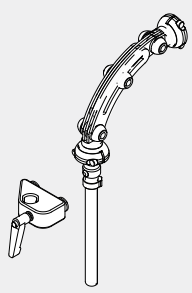
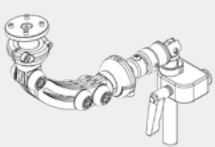
STEP 2: Select Hardware System

HARDWARE SYSTEM				
				
AXYS	LINX 4"	LINX 8"	LINX 10"	LINX 15"
1480-4913-100	1480-4961-004	1480-4961-008	1480-4961-010	1480-4961-015
				
LINX2 4"	LINX2 8"	LINX2 10"	LINX2 15"	PRO PADIATRIC
1480-4962-004	1480-4962-008	1480-4962-010	1480-4962-015	1480-4934-101
				
PRO ADULT	COBRA XTRA PADIATRIC	COBRA XTRA ADULT	COBRA XTRA FLIPBACK	STYLO 160
1480-4934-100	1480-4923-102	1480-4923-103	1480-4922-100	1274-1282-500
				
STYLO FLIPBACK 160	STYLO 260	STYLO FLIPBACK 260		
1274-2252-500	1274-1252-500	1274-2282-500		

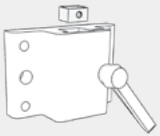
STEP 3: Select Mount Bracket

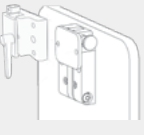
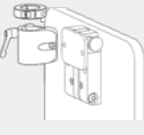
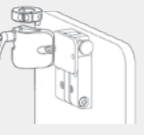
MOUNT BRACKET					
	AXYS	LINX / LINX2	PRO	COBRA	STYLO
Detachable				COBRA XTRA Hardware System includes detachable mounting bracket.	STYLO 160 and STYLO 260 Hardware Systems include detachable mounting bracket.
	1480-4911-100	1481-M2300	1480-4931-100		
Swing-Away				Select COBRA XTRA Flip Back Hardware System for swing-away capability.	Select STYLO FLIP BACK 160 or STYLO FLIBACK 260 Hardware System for swing-away capability.
	M5000	M5000	M5000		

STEP 4: Select Occipital Pad (Optional)

OCCIPITAL PAD				
Padiatric 5" Pad (For Short Infant Size)	Adult 6" Pad (For Short Small Size)	Plush 8" Pad (For Short Medium Size)	Plush 10" Pad (For Short Large Size)	
1480-4612-281	1480-4613-281	1480-4108-281	1480-4110-281	
*Available on short height pads only.				









Required For STEP 4

BRACKET

Sub-Occipital Flared Tabs Single Sub-Occipital Bracket
1480-4942-100

Lateral Facial Support Ordering Guide

STEP 1: Select Facial Pad

FACIAL PADS							
							
Spot	Standard	Long	Curved	Oval	Large-C	Med-C	Small-C
1481-PL10L	1481-PL15L	1481-PL20L	1480-4612-281	1480-4613-281	1481-PL30L	1481-PL35L	1481-PL40L

STEP 2: Select Stem

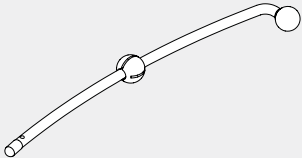
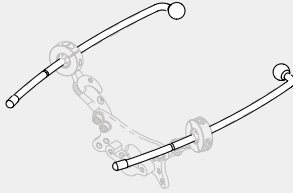
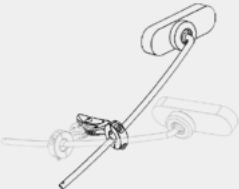
STEMS		
		
Unilateral	Bilateral	Anterior
1481-LM1010	1481-LM1010 x 2	1481-LM1096



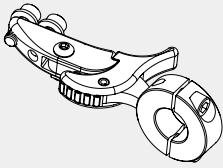
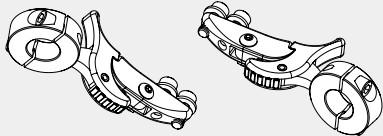
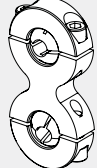

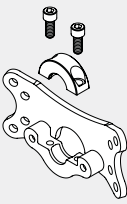
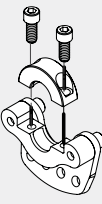

STEP 3: Select Mount

UNILATERAL	BILATERAL	ONE PER SIDE
		
Swing-Away Mount	Swing-Away Mount	Infinity
1481-LM115	1481-LM115 x 2	1481-242161

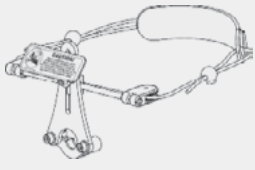
STEP 4: Select Adaptor

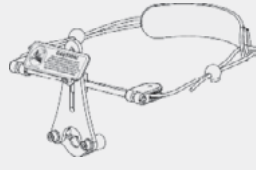
PLUSH	CONTOURED CRADLE
	
Plush Lateral Interface Plate	Contoured Cradle Lateral Interface Plate
1481-LM-PL	1481-LM-CCS

STEP 5: Select Anterior Support (Optional)

ADULT			
			
Dynamic Forehead Strap	Dynamic Forehead Strap Rigid	Strap Cap (Black)	
1480-4822-000	1480-4832-000	1480-4842-099	
PADIATRIC			
			
Dynamic Forehead Strap	Dynamic Forehead Strap Rigid	Strap Cap (Red)	Strap Cap (Blue)
1480-4821-000	1480-4831-000	1480-4841-020	1480-4841-060

Required For STEP 5

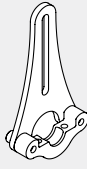
INTERFACE

Anterior Support Interface
1481-D1010

medifab®

Distributed by Medifab Ltd

22 Detroit Drive
Rolleston 7675
New Zealand

+64 3 307 9790

solutions@medifab.com

www.medifab.com



DISTRIBUTED BY:

Script: HeadsUp_20201118