

medifab

Shaping Better Lives



AUSTRALIA
CLINICAL EQUIPMENT
SOLUTIONS

MEDIFAB.COM





Our vision is to
make a positive
difference to
people living
with disabilities.

Contents

Shaping Better Lives	4	Standing Aids	60
Strollers	10	Jenx Monkey Stander	64
BINGO Evo Mini Stroller	14	Jenx Multistander	65
BINGO Evo Stroller	16	Jenx Multistander with Abduction	66
BINGO Spex Stroller	18	Jenx Standz Size 1	67
Pixi Stroller	22	Jenx Standz Size 2	68
Duro Stroller	23	Jenx Supine Stander	70
Kool Stride Sports Buggy	24	Bathroom	72
Indoor Seating	26	Sharky Bathroom Chair	74
Gravity Chair	30	Lying & Positioning	76
Cobra Base	31	Poz-in-Form	78
Jenx Atom	32	CareWave	82
Jenx Junior+	34	Simple Stuff Works	88
Therapy	36	Dreama	94
Jenx Corner Seat	38	Sleep	98
Jenx Nursery Table & Therapy Bench	39	Safe Surround Genie Bed	100
Jenx Ly-on	40	Safe Surround Plus Bed	101
Kid'InForm Ultimate KIT/Positioning System	42		
Vehicle Seating	44		
Carrot 3000 Car Seat	46		
Carrot XL Car Seat	48		
Hero Car Seat	50		
Starlight Car Seat	51		
Ipai LGT Car Seat	52		
Houdini Harnesses	54		
Walking Rein	58		

Key



Therapists Normally Choose



Order Me In



Script To Suit

medifab

Shaping better lives since 1990.

Grown from small beginnings, the Medifab story is driven by a single-minded purpose – to bring comfort and functionality to people living with disabilities.

We design and manufacture specialist seating and high-quality clinical equipment for children and adults with complex medical needs. Established in 1990 with a genuine passion to help, we innovate to create break-through technologies, so our clients can manage their daily physical and cognitive challenges with the dignity they deserve.

Working closely with therapists, carers and clients, our customer-focussed approach and 'whatever it takes' attitude is at the heart of everything we do. And now, as a leading manufacturer and supplier of high-quality clinical equipment, we continue to push boundaries and adapt our solutions so we can shape better lives in Australia.



medifab

A culture of going “the extra smile”.

We are driven by a single-minded purpose – to bring comfort and functionality to people living with disabilities. Every day, we work towards our mission: ‘**shaping better lives**’. And our values underpin everything we do.



Our company values

- L LOYALTY**
We're committed to the company, team and every one of our customers.
- I INTEGRITY**
We uphold the strongest moral and ethical principles every day.
- V VICTORY**
We achieve and succeed in everything we do.
- E ENTHUSIASM**
We're passionate about shaping better lives.
- S SOLUTIONS**
We're creative, forward thinking solution-finders.

At Medifab, we specialise in comfort and functionality for those living with disabilities and medical conditions in simpler terms, we 'shape better lives'. You may wonder how we do it. We also specialise in Complex Rehabilitation Technology (CRT) equipment and this enables us to make a positive difference. We understand that the best way to implement lasting change is to provide individuals with the equipment they need to stay active, comfortable and functional within their homes and communities. With knowledgeable staff and maximising the latest innovations, our breakthrough CRT products play a critical role in helping those less able to tackle their daily physical and functional challenges with comfort and ease.

Our world-leading equipment includes strollers and pushchairs, indoor seating, car seats and harnesses, standing and walking aids, beds, sleep systems, and therapy equipment.



Our support network

Fast delivery of world-leading equipment

We are a trusted stockist for many global brands, and our dedicated team of logistics staff, procurement managers and supply chain specialists facilitated by our quality and regulatory team ensure timely supply to the highest industry standards. This allows us to support Australians living with disabilities with fast supply through our well-established support network of 40+ distributors. We also supply New Zealand through our home base, warehouses and clinics.



Our expert knowledge base

We realise that if we want to improve the lives of people living with disabilities and medical conditions, we must share our knowledge with other health professionals. We do just that at conferences, workshops and training events around the world. This is facilitated through the Medifab Professional Development Academy or by partnering with one of our distributors.



Joana Santiago, BSc OT

Head of Clinical Education

Led by our Australian-based Clinical Educator, Joana Santiago, our knowledge base gives carers, medical professionals and therapists the information and tools they need to improve their patients' lives. An Occupational Therapist with experience working in five different countries, Joana has a comprehensive understanding of postural management and how it can influence everyday functionality and health.



Jamie Cockle

Paediatric Clinical Educator

Trained physiotherapist, Jamie Cockle is our Paediatric Clinical Educator and Seating and Positioning Specialist. He provides dedicated training and support for therapists, product specialists and families, helping them to understand the key principles behind Medifab's range of paediatric equipment.



Encouraging independence and individuality



Revolutionary wheelchair comfort

A revolution within the clinical equipment industry, our Spex wheelchair seating system combines clear-cut design advantages with innovative functional features to create a fully adjustable and customisable system that is propelling people's comfort levels to new heights. A dependable and reliable design that maintains any configuration once set, Spex is quickly and easily adjusted on the spot, enabling carers and therapists to provide optimal comfort for users in as short a time frame as possible. Designed to increase people's ability to lead functional, active lives, the Spex SuperShape can be fitted and adjusted anywhere. The extreme contouring capabilities of the Spex SuperShape Back Support perfectly moulds to the individual's unique trunk shape, providing superb comfort, postural integrity and pressure relief for wheelchair users.

Spex Catalogue

spex

Shaping Better Lives



CLINICAL
WHEELCHAIR
SEATING

—
SPEXSEATING.COM

Do you have this resource?

Email solutions@medifab.com to request a copy

Freedom to explore





Strollers



Our mission is to enable parents to lead a dynamic, fun and active lifestyle. Gain peace of mind knowing your child's needs are cared for with clinical and ergonomic support for the best start in life!

BINGO Evo Mini Stroller	14
BINGO Evo Stroller	16
BINGO Spex Stroller	18
Pixi Stroller	22
Duro Stroller	23
Kool Stride Sports Buggy	24

Stroller Comparison Chart



Specifications	BINGO MINI	BINGO EVO			BINGO SPEX	
		Size 1	Size 2	Size 3	Size 1	Size 2
Description	Ultimate early intervention seating with smart outdoors stroller	Versatile and modular buggy system for basic needs, up to critical care users.			A smart - looking stroller with superior postural support, that enables parents to take their child outside and explore!	
APPROX AGE OF USER*	4mths - 4yrs	1 - 5yrs	3 - 12yrs	8 - 15yrs	2 - 5yrs	3 - 7yrs
MAX LOAD (kg)	25	50			50	
SEAT WIDTH (cm)	13 - 25	18 - 30	23 - 35	23 - 35	17 - 28	22 - 33
SEAT DEPTH (cm)	12 - 27	16 - 34	22 - 40	30 - 45	18 - 30	23 - 38
SHOULDER HEIGHT (cm)	25.5 - 39.5	28 - 46	34 - 55	42 - 63	36 - 44	40 - 48
FOOT SUPPORT HEIGHT RANGE (cm)	16 - 34	19 - 40	19 - 40	19 - 40	25 - 40	25 - 45
FRONT/REAR FACING	Both	Both			Both	
INDOOR FRAME OPTIONS	✓	✓			✓	
APPROX PRODUCT WEIGHT (kg)	17.5	15	16.1	18	29	30
TILT IN SPACE	45°	45°			45°	
RECLINE	80° - 180° in 10° steps	90° - 160°	90° - 135°		90° - 160°	
FOOT SUPPORT ELEVATION	✓	✓			✓	
GROWTH ADJUST SEAT	✓	✓			✓	
SWIVEL FRONT WHEELS	✓	✓			✓	
ACTIVITY TRAY	✓	✓			✓	
SUN CANOPY	✓	✓			✓	
RAIN SHIELD	✓	✓			✓	
BASKET STORAGE	✓	✓			✓	
POSTURAL SUPPORT LEVEL	Mod./Complex	Mod./Complex			Complex	
TYRE SOLID / PNEUMATIC	Solid	Solid			Solid	
TRANSPORT APPROVED	✓	✓			✓	

* Indicator only, for accurate product selection client measurements are the best guide.

STROLLER COMPARISON CHART



PIXI		DURO		KOOL STRIDE
Size 1	Size 2	Size 1	Size 2	
Light and nimble buggy with comfortable rigid seating. Child can step on foot support to self - transfer.		Configurable stroller for everyday challenges, with great range of support and positioning accessories.		Go off road and beyond!
3 - 7yrs	6 - 14yrs	3 - 12yrs	8 - 15yrs	8 - 21yrs
35	50	75		70
28	33	23 - 34	28 - 39	43
25 or 30	35 or 40	26 - 40	31 - 45	30
54 or 60	64 or 70	32 - 40	42 - 62	60
13 - 35	13 - 39	20 - 44	20 - 44	45
Front		Front		Front
✗		✗		✗
12.5	15	19.2	21	15
✗		Static 16° or 20°		✗
90° - 125°		78 - 120°		✗
✗		✓		✗
5cm growth bracket, Seat depth & Back height		✓		✗
✓		✓		✗
✓		✓		✗
✓		✓		✓
✓		✓		✓
✓		✓		✓
Moderate		Moderate		Mild
Combination		Solid		Pneumatic
✓		✓		✗

Medifab is as diligent as possible in compiling this information. Medifab does not guarantee the correctness and completeness of the information provided. Equally, Medifab does not guarantee that this information is up to date. For questions concerning our products, their specifications and their utilisation please refer to the instruction manual and/or a product consultant of Medifab. Product specifications are subject to change without notice.

BINGO Evo Mini Stroller

Medifab's newest early intervention stroller with a wide range of accessories and options to meet the needs of different children.

Specialised Early Intervention Tilt Stroller



Adjustable seat unit
Seat depth and width, back support height and lower leg length

Individual upholstery
Removable seat, back, head and laterals cushions allow easy customisation

Multi-directional suspension **protects the child** by absorbing ground bumps, and is effective off road or on rough terrain

Ergonomic, height-adjustable push handle

Sun canopy option available to allow parents and caregivers to still get out and about, knowing the child is protected from the sun

Stepless seat depth adjustment

Mini Package Includes:

Removable seat, matte black mobility base with swivel front black mag wheels and solid tyres, tie-downs, hip guides, basket, adjustable suspension, receiver for supports & foot support.



Colour Options:



Turquoise Soft (-349)



Berry Soft (-347)



Black (-346)

ONE SEAT. TWO BASE OPTIONS

Indoor Cobra base option available. Height adjustable with the child seated.



ADAPTIVE SUSPENSION SYSTEM

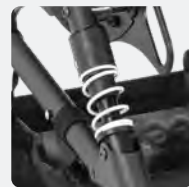

Fourfold adjustable frame suspension system which can be easily adjusted without tools.

TILT

The special construction of the tilt mechanism allows a 45° tilt of the seat unit without compromising the overall stability.



COMPACT FOLDED SIZE



Easier to store in a car boot! The innovative folding mechanism can be released easily on the push bar.

BACK SUPPORT RECLINE

The operating elements of the tilt & back support recline are positioned centrally and allow for easy and secure handling.



Size	Code	Seat Load Capacity	Push Handle Height	Overall Width	Seat Depth	Seat Width	Back Support Recline	Shoulder Height	Foot Support Height	Overall Weight	Indoor Base Seat Height	Indoor Base Footprint
0	2880-0008-000	25 kg	75-110 cm	63 cm	12-27 cm	13-25 cm	80-180°	25.5-39.5 cm	16-34 cm	17.6 kg	27-67.5*	61cm (W) x 71cm (L)

* Depending on size of castors

Accessories

Lateral Head Support Pads
0: 2880-4470-346



Upholstery pressure-relief foam upgrades
Seat: 2880-0391-000
Back: 2880-2392-000



Occipital Head Support Spacer: 2010-4101-099
Wipe Down: 2010-4101-209



Std Lateral Head Support Spacer: 2010-4201-099
Wipe Down: 2010-4201-209



Ext Lateral Head Support Spacer: 2010-4301-099
Wipe Down: 2010-4301-209

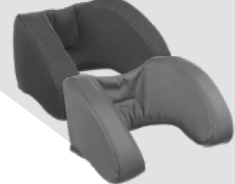

Lateral Trunk Support
0: 2880-3009-346
Pressure-relief upgrade
2880-3846-400



Spex Lateral Trunk Supports
Narrow Straight: 2880-3007-100
Broad: 2880-3007-310
Teardrop: 2880-3007-500



Seat options
Sacral Support:
2020-2510-060

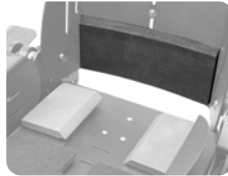

Seat options
Thigh Wedge:
2006-0505-000

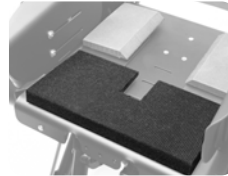

Seat options
Trochanter Wedges:
2006-0660-000

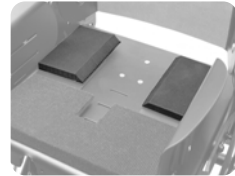

Therapy Tray
Can't be used with grab rail
1: 2880-7111-000
Infill: 2880-7180-000



Grab Rail
Can't be used with tray
2880-7250-346



Medial Knee Support
1: 2880-1651-346



Foot Support Spacer
2880-5321-000



Neoprene Foot Support Cover
2880-5305-000



Oxygen Bottle Holder:
2880-8253-000



Chassis Mount Tray
2880-8058-000



Ankle Supports
2880-6101-000



Accessory Bag
Handle-bar strap system
2880-8012-099



Hand Strap:
For AS/NZS 3696.19
2005-6930-000



Swivel Lock:
2880-8440-000



Cobra Indoor Base
0: 2880-8720-000



Spex 5-Point Anterior Chest Support:
2006-6551-000

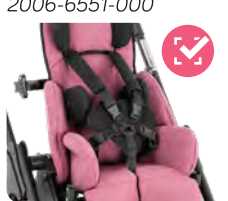

IV Pole:
2880-8275-000



Sun Canopy & Rain Shield:
With mounts & rain shield
2880-7501-346



BINGO Evo Stroller

Larger supportive seating system with many features, including a wide range of accessories and options to meet the needs of different children.

Modular seating & positioning stroller



Ergonomic, height-adjustable push handle

Adjustable seat unit
Seat depth and width, back support height and lower leg length

Individual upholstery
Removable seat, back, head and lateral trunk support cushions allow easy customisation

Stepless seat depth adjustment

Sun canopy option available to allow parents and caregivers to still get out and about, knowing the child is protected from the sun

Multi-directional suspension **protects the child** by absorbing ground bumps, and is effective off road or on rough terrain

Evo Package Includes:

Removable seat, matte black mobility base with swivel front black mag wheels and solid tyres, tie-downs, hip guides, basket, adjustable suspension and 3 sided foot support.



Colour Options:



Turquoise Soft (-349) Berry Soft (-347) Black (-346)

ONE SEAT. TWO BASE OPTIONS

Indoor Cobra base option available. Height adjustable while the child is seated.



ADAPTIVE SUSPENSION SYSTEM



Fourfold adjustable frame suspension system which can be easily adjusted without tools.

TILT

The special construction of the tilt mechanism allows a 45° tilt of the seat unit without compromising the overall stability.



COMPACT FOLDED SIZE



Easier to store in a car boot! The innovative folding mechanism can be released easily on the push bar.

BACK SUPPORT RECLINE

The operating elements of the tilt & back support recline are positioned centrally and allow for easy and secure handling.



Size	Code	Seat Load Capacity	Overall Length	Overall Width	Seat Depth	Seat Width	Back Support Recline	Shoulder Height	Foot Support Height	Overall Weight	Indoor Base Seat Height	Indoor Base Footprint
1	2881-0009	50 kg	92 cm	63 cm	16-34 cm	18-30 cm	90-160°	28-46 cm	16-37 cm	15 kg	27-67.5*	61cm (W) x 71cm (L)
2	2882-0009			68 cm	22-40 cm	23-35 cm	90-160°	34-55 cm	16-40 cm	16.1 kg		
3	2883-0001			68 cm	27-45 cm	23-35 cm	90-135°	42-63 cm	16-40 cm	18 kg		

* Depending on size of castors

Accessories

Head Support Pads
1: 2880-4471-346
2: 2880-4472-346



Head Support Speakers
2880-8330-000
(Head support pads required)



Occipital Head Support
Spacer: 2010-4101-099
Wipe Down: 2010-4101-209



Std Lateral Head Support
Spacer: 2010-4201-099
Wipe Down: 2010-4201-209



Ext Lateral Head Support
Spacer: 2010-4301-099
Wipe Down: 2010-4301-209



Std Lateral Trunk Support
1: 2880-3010-346
2: 2880-3020-346
3: 2880-3030-346



Spex Lateral Trunk Supports
Narrow Straight: 2880-3008-100
Broad: 2880-3008-310
Teardrop: 2880-3008-500



Additional Padding
Sacral Support: 2020-2510-060
Thigh Wedge: 2006-0505-000



Medial Knee Support
1: 2880-1651-346
2: 2880-1652-346
3: 2880-1653-346



Anterior Chest Support
1: 2880-6751-346
2: 2880-6752-346
3: 2880-6753-346



Spex Centrepoint Anterior Chest Support
XS: 1409-5660-017
S: 1409-6661-017



5-Point Anterior Chest Support:
2880-6511-346



Spex Hip Belt
2-Point: 1405-6220-027
4-Point: 1406-6420-027



Groin Strap
1: 2880-6361-346
2-3: 2880-6362-346



Foot Support Spacer
4cm thick
1: 2880-5321-000
2: 2880-5322-000



Ankle Foot Fast
1: 2880-6101-000
2: 2880-6102-000



Therapy Tray
1: 2880-7111-000
2-3: 2880-7112-000
Infill: 2880-7180-000



Grab Rail
1: 2880-1651-346
2-3: 2880-1652-346



IV Pole:
2880-8275-000



Oxygen Bottle Holder:
2880-8253-000



Chassis Mount Tray
1: 2880-8058-000
2: 2880-8059-000



Swivel Lock:
2880-8440-000



Sun Canopy & Rain Shield:
2880-7500-346



Cobra Indoor Base
1: 2880-8711-000
2: 2880-8721-000



BINGO Spex Stroller

A breakthrough in rehabilitative stroller seating.

The BINGO Spex provides a solution for paediatrics that has never been seen before. For children with positioning needs where a stroller is the preferred option for the family, the BINGO Spex provides an optimum seating support designed to accommodate even the most challenging postures.



Create clinical solutions with Spex cushion and back support system.



ALLOWANCE FOR HIP/THIGH FLEXION AND PRE-ISCIAL SUPPORT

A good pelvic foundation is paramount to assist in slowing, or even preventing pelvic and spinal asymmetries. Therefore, the cushion adjusts to correct or accommodate the child's pelvic and thigh needs.



SPEX POSITIONING CUSHION BASE

Strategic positioning pads can be added or removed from underneath the cushion to allow for different contours and shapes. This way we can meet the client's posture requirements present today; and readjust them in the future.



PELVIC OBLIQUITY BUILD-UP

Pelvic obliquity build-up can be achieved and easily adjusted under the cushion ischial well. Its adjustable pre-ischial area can be conformed on-the-spot for greater or lesser anti-thrust needs.



CREATE INSTANT SHAPE

Back support shaping allows for accommodation or correction of trunk deformities, that will ultimately be supported through multi-adjustable lateral trunk supports and anterior chest supports.



SPEX CONTOURING SYSTEM

Create a modular and adjustable solution which can be tailored to meet the individual support needs of each child.



ASYMMETRICAL CONTOURING

Back support adjustable shaping can be easily adapted to meet common spinal deformities, such as Scoliosis, Lordosis, and Kyphosis.

BINGO Spex Stroller

A smart-looking stroller that enables parents to take their child outside and explore! (A sun canopy is included in the package.)



Adjustable suspension system.



Adjustable recline, seat tilt and elevating foot support.



COMFI HEAD SUPPORT

Ultimate comfort and positioning for the head with inbuilt lateral and occipital support. 2 styles available: standard lateral and extended lateral (shown).
Standard 2885-4241-XXX
Extended 2885-4341-XXX

Superior comfort and style

With a wide range of coloured seating options to choose from, the BINGO Spex offers a colour to suit any style. Stand out from the crowd with our Chilli Red or look pretty in pink with the Calypso.



BLACK
-099

BUMBLEBEE
-044

CALYPSO
-028

CHILLI
-022

GRANITE
-090

LEAF
-054

MANGO
-030

OCEAN
-060

ROYAL
-077

BINGO SPEX TECHNOLOGY

- Spex cushion
- Spex back support
- Axial lateral trunk supports
- Forearm supports

FRAME AND SEAT FEATURES

- BINGO OT mobility base in matte black
- Open footrest platform
- Tray table
- Elevating legrest allowing for contractures 85°-160°
- Sun Canopy and Rain Shield

- Basket
- Transport tie-downs

OPTIONS

- Hip belt positioning
- Anterior chest supports
- Comfi head supports
- Oxygen bottle holder
- IV pole
- Weather gear
- Ventilator tray for respiratory equipment
- Feet sandals
- Height-adjustable indoor base
- Axial Pelvic Supports

BINGO Spex Stroller User measurements

BINGO Stroller Size		Size 1		Size 2		
BINGO Stroller Order Code		2885-0031-032		2885-0032-032		
Seating specs	A Hip width	17-28cm (6.5-11")		22-33cm (8.5-13")		
	B Seat depth	18-23cm (7-9") 1.1 Cushion	23-30cm (9-12") 1.2 Cushion	23-33cm (9-13") 2.1 Cushion	28-38cm (11-15") 2.2 Cushion	
	C Back height	36-44cm (14-17")		40-48cm (16-19")		
	D Lower leg length*	25-40cm (10-16")		25-45cm (10-18")		
	E Lateral trunk support width	12-28cm (5-11")		15-30cm (6-12")		
	F Lateral trunk support height	15-34cm (6-13.5")		17-40cm (6.5-16")		
	G Arm support height	15-22cm (6-8.5")		15-22cm (6-8.5")		
	H Internal arm support width	20-32cm (8-13")		28-38cm (11-15")		
	I Head support height**	45-65cm (18-25.5")		50-70cm (20-28")		
	J Cushion total width	33cm (13") Size 1.1	33cm (13") Size 1.2	38cm (15") Size 2.1	38cm (15") Size 2.2	
	K Internal cushion width	23cm (9") Size 1.1	28cm (11") Size 1.2	28cm (11") Size 2.1	33cm (13") Size 2.2	
	L Centre of thigh contours	15cm (6") Size 1.1	17cm (6.5") Size 1.2	18cm (7") Size 2.1	20cm (8") Size 2.2	
	M Cushion side height	14cm (5.5")		14cm (5.5")		
	N Thigh contour height	9cm (3.5")		9cm (3.5")		
	O Abductor contour height	5cm (2")		5cm (2")		
	P Back cushion width	33cm (13")		38cm (15")		
	Q Trunk cushion width	26cm (10")		30cm (12")		
	Stroller specs	Frame seat depth capacity	18-30cm (7-12")		20-38cm (8-15")	
		Frame back height capacity	36-46cm (14-18")		41-55cm (16-22")	
Back support recline angle		90-160°				
Height of push bar		75-110cm (29.5-43")				
Overall frame width		63cm (25")		68cm (27")		
Max load of seat unit		50kg (110lb) (body weight including other load)				
Base frame capacity	60kg (132lb)					

Stroller Package includes matte black frame with tie downs, 3 kg fabric basket, tray table, and sun canopy.

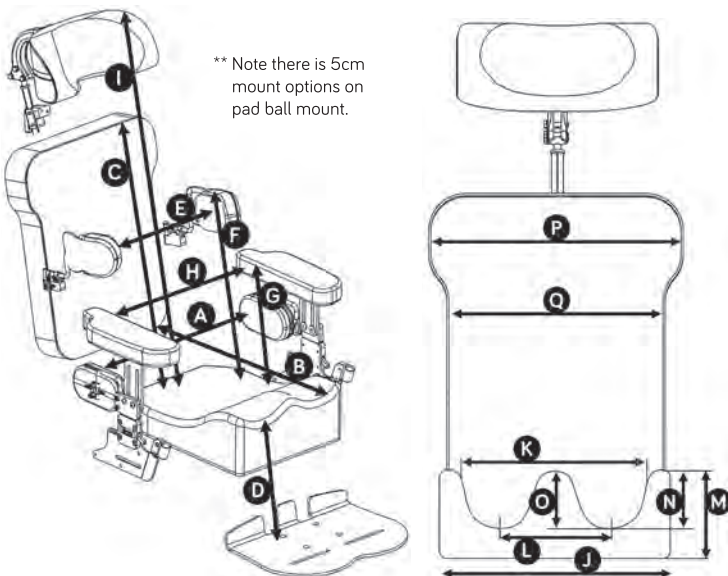

Adjustable seating and stroller



Cobra height-adjustable indoor base. The seat easily transfers into the Cobra for feeding and activity times. Tilt setting can still be adjusted.
Size 1: 2880-8711-000
Size 2: 2880-8721-000



Seat in forward facing direction.



Seat in rear facing direction.

Rehabilitative care improves with innovative Spex seating.



AXIAL PELVIC SUPPORTS

Multi-adjustable pelvic supports can orientate in width and angle for optimum pelvic control. These pads are mounted to the quick-release hardware meaning transfers are easy.
Size 1: 2885-1111-000
Size 2: 2885-1112-000



SPEX BACK SUPPORT

Comfortable pressure-reducing back support with contouring cell system to permit a personal contour for bony prominences, scoliosis and other asymmetrical back postures.
Size 1: 2885-2012-OXX
Size 2: 2885-2014-OXX



SPEX SUPERHIGH CUSHION

Specially designed for a young child who has moderate to high positioning requirements. Spex Superhigh offers optimal adduction and abduction contours to effectively position the pelvis and legs. Spex positioning technology allows further adjustment for pelvic obliquity, hip flexion and other clinical requirements.
1.1: 2885-0610-OXX **1.2:** 2885-0611-OXX
2.1: 2885-0612-OXX **2.2:** 2885-0613-OXX



AXIAL LATERAL TRUNK SUPPORTS

Comfortable lateral trunk supports that are width, depth and multiple angle adjustable. Patented mechanically rotational system allows the lateral pad to rotate to correctly align to the user's trunk. Swing-away hardware make it easy for carers to transfer the child in and out.
Narrow: 2885-3410-291
Broad: 2885-3431-291



FOREARM SUPPORTS

Comfortable, padded forearm supports on quick-release hardware make transfers easy for the carers.
Size 1: 2885-5621-291
Size 2: 2885-5622-291



FEET POSITIONING SANDALS

Straps can be fixed in a variety of ways to achieve the most appropriate support for each child. Independently adjustable to exactly accommodate the optimum foot position.
Sandals: 2885-6081-000
Sandal Raising Blocks: 2885-6091-000

Pixi Stroller

An attractive, lightweight stroller with rigid seating shell construction.

Outstanding stability & quick, easy folding



Easy kerb navigation
Handle bar which extends over rear axle

Back support recline
allows the child to sleep or relax

Easy rear wheel brake system

Manoeuvrable!
Great stroller to push, with ball bearing castors to easily navigate shopping malls and more

Robust, **sturdy design** for excellent reliability

Unique **step-up foot support** with strong design that won't tip stroller up when the child climbs in

Configure for postural support

- Vest anterior chest support 1409-6611-017
- Pre-ischial support 2560-0500-070
- Sacral support pad 2560-2500-046
- Scapula support wedge 2560-2700
- Back support infill spacer 2560-2800-032
- Foot support spacer block 2560-5301
- Padded ankle straps 2560-6101-017

Configure for behaviour issues

- Anti-escape hip belt 1405-6211-026
- Anti-escape tee-pad anterior chest support configuration 2560-6556-026
- Pen-release hip belt 1405-6211-025



User can self-transfer with unique 'step-up' foot support, to save caregivers from lifting them into the buggy.



Parents feel great with this smart design.



Quickly folds down to a compact size to place in a vehicle boot. Easy 'lift-to-fold' catches.

ACCESSORIES

Standard package includes stroller with plush wipeable upholstery and step-up foot support.

Basket
1 2560-8011-017
2 2560-8012-017



Chest Strap complete with lateral pads
1 2560-6801-090
2 2560-6802-090



Tray Table
1 2560-7120-013
2 2560-7130-013



Lateral Head Support
Standard 2560-4200-966
Extended 2560-4300-966



5 Point Anterior Chest Support
2560-6511-000

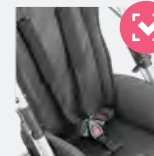

Medial Knee Support
2560-1501-090



Rain Shield Cover
2560-7601-010



UV Shade Cover
2560-7701-010



Sun Hood
1 2560-7543-090
2 2560-7544-090



Grab Rail
1 2560-7253-299
2 2560-7254-299



Tie-Downs
2560-8501-021



Size	Code	Approx Age Of Child	Approx Weight Of Child	Seat Depth	Seat Width	Shoulder Height	Foot Support Height	Approx Stroller Weight
1	2563-0006-191	3 - 7 yrs	35kg	25 or 30 cm	28 cm	36 - 45 cm	18 - 30 cm	12.5 kg
2	2566-0006-191	6 - 14 yrs	50kg	35 or 40 cm	32 cm	45 - 55 cm	18 - 35 cm	15 kg

Duro Stroller

Whether navigating city footpaths or the outdoors terrain, Duro is a stable stroller solution with a great range of support and positioning accessories that will enable you to embrace the outdoors.

Configurable rehab stroller for everyday challenges



Extremely agile with **great manoeuvring** due to compact mobility base

Adjustable back angle

2 options for seat angle

Adjustable knee angle

Generous **growth capacity** provides long-term use for growing users

Individually customisable to suit requirements, with proven accessories from the **BINGO Evo Stroller**

Very stable stroller option



Super compact folding makes the Duro easy to transport and stow in the boot of your car!



Reclining back support means you can relax back in the Duro when being out and about gets tiring!

Colour options: *(Upholstery must be selected in addition to Stroller)*

Turquoise
Size 1:
2780-8801-339
Size 2:
2780-8802-339



Red
Size 1:
2780-8801-345
Size 2:
2780-8802-345

ACCESSORIES

Standard package includes: hip supports, swivel front wheels, flip-up foot support, soft accessory bag, tie-down kit and retainer for accessories.

Head Support Pads
1 2880-4461-000
2 2880-4462-000

Head Support Speakers
2880-8330-000
(Head support pads required)



Occipital Head Support Spacer: 2010-4101-099
Wipe Down: 2010-4101-209

Std Lateral Head Support Spacer: 2010-4201-099
Wipe Down: 2010-4201-209



Std Lateral Trunk Support
1: 2880-3010-000
2: 2880-3020-000
3: 2880-3030-000

Contoured Lateral Trunk Support: 2006-3030-099
Teardrop Lateral Trunk Support: 2006-3110-099

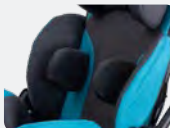

Spex Centrepoint Anterior Chest Support
XS: 3780-4301-209
S: 3780-4301-009

5-Point Anterior Chest Support: 3780-4101-209

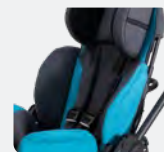

Ankle Foot Fast
1: 2880-6101-000
2: 2880-6102-000

Therapy Tray
1: 2880-7111-000
2-3: 2880-7112-000
Infill: 2880-7180-000

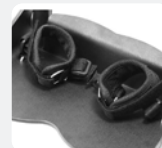

Full range of accessories available on page 17

Size	Code	Weight Limit	Seat Width	Seat Depth	Seat Angle	Back Support Height	Back Support Angle	Lower Leg Length	Wheel Diameter	Folded Size (L x W x H)
1	2780-0001-052	75 kg	23 - 34 cm	26 - 40 cm	16° or 20°	45 - 63 cm	78 - 120°	20 - 44 cm	20 cm front, 30 cm rear	84x63x32 cm
2	2780-0002-052	75 kg	28 - 39 cm	35 - 45 cm	16° or 20°	62 - 83 cm	78 - 120°	20 - 42 cm	20 cm front, 30 cm rear	84x68x38 cm

Kool Stride Sports Buggy

This popular stroller for larger children with disabilities now has a unique advanced feature: an extendable rear wheel system. As the user grows, the rear wheels can extend backwards to maintain stability and control.

Lightweight all-terrain buggy for 10 year old to young adults



Dual parking brakes

Lightweight aluminium frame

5-point safety anterior chest support

Weight limit of 60 kg

Carrier basket under seat, and pocket on the back of the seat which can be used to hold drink bottles etc.

5°, cambered large wheels make walking easy on pathways, gravel or grass

EXPLORE...

Serious sports buggy for cruising outdoors!

- Jogging
- Bushwalks
- Beaches
- Farms
- and much more...



Travelling made easy

Quick release wheels for easy folding down, simple storage and transport.

ACCESSORIES

Rain Cover
2650-7600-010

UV Cover
2650-7700-260



Roll the sunhood side flaps up to let the cool air in



Stow the sunhood back



Folds flat and compact for transportation

Code	Seat Depth	Seat Width	Shoulder Height	Seat Back Height	Foot Support Height	Overall Width	Max Load	Rear Wheel Diameter	Approx Stroller Weight
2650-0001-000	30 cm	43 cm	50 cm	60 cm	45 cm	68 cm	60 kg	50 cm	15 kg





Indoor Seating



We provide seating solutions that are designed to support children so they can play and learn. Our indoor seating range facilitates inclusion, whether at home or at school, ensuring children have endless opportunities to develop their skills.

Easy to adjust solutions with numerous accessory options ensure that tailored support is met with comfort and practicality.

Gravity Chair	30
Cobra Base	31
Jenx Atom	32
Jenx Junior+	34

Indoor Seating Comparison Chart



SPECIFICATIONS	JENX CORNER SEAT			BINGO				BINGO SPEX	
	Size 1	Size 2	Size 3	BINGO Mini	BINGO 1	BINGO 2	BINGO 3	Size 1	Size 2
DESCRIPTION	Popular as the child's first seating system at floor level.			High & Low level seating for the BINGO				High & Low level seating for the BINGO Spex	
APPROX AGE OF USER*	6 mths-2 yrs	1 - 6 yrs	4 - 10 yrs	4 mths-4 yrs	1 - 5 yrs	3 - 12 yrs	8-15 yrs	2 - 5 yrs	3 - 7 yrs
USER WEIGHT (kg)	25	35	55	25	50	50	50	50	50
SEAT WIDTH (cm)	33	39	49	13 - 25	18 - 30	23 - 35	23 - 35	17 - 28	22 - 33
SEAT DEPTH (cm)	35	37	46	12 - 27	16 - 34	22 - 40	27 - 45	1.1: 18 - 23 1.2: 23 - 30	2.1: 23 - 33 2.2: 28 - 38
BACK SUPPORT HEIGHT (cm)	31 - 42	44 - 62	50 - 68	37 - 51	45 - 63	54 - 75	62 - 83	36 - 44	40 - 48
FOOT SUPPORT HEIGHT (cm)		N/A		16 - 34	16 - 37	16 - 40	16 - 40	25 - 40	25 - 45
TILT IN SPACE		✗		45° posterior					
RECLINE		✗		70°					
GROWTH ADJUST SEAT		✓		✓	✓	✓	✓	✓	✓
SEAT HEIGHT (cm)		N/A		27 - 61	27 - 61	27 - 61	27 - 61	27 - 61	27 - 61
HI LO OPERATION		N/A		Hand Operated Gas Assist					
TRAY		✓		✓	✓	✓	✓	✓	✓
POSTURAL SUPPORT LEVEL	Mild/Moderate			Mild/Moderate/Complex					

* Indicator only, for accurate product selection client measurements are the best guide. Medifab is as diligent as possible in compiling this information. Medifab does not guarantee the correctness and completeness of the information provided. Equally, Medifab does not guarantee that this information is up to date. For questions concerning our products, their specifications and their utilisation please refer to the instruction manual and/or a product consultant of Medifab. Product specifications are subject to change without notice.



JENX ATOM	JENX JUNIOR+ SEAT			GRAVITY CHAIR			
	Size 1	Size 2	Size 3	Sml	Med	Lrg	XLrg
A modular seating system for users 6 months - 5 years	Comfortable, contoured and stable modular seating system, with outstanding levels of adjustment and a wide variety of support options.			Supportive alternative seating and foam positioning system to augment postural control for a wide range of individuals. Also used as a 'hugging' chair for individuals who benefit from this type of sensory input.			
6 mths - 5 yrs	18 mths - 5 yrs	3 - 8 yrs	5 - 12 yrs	Refer to Measurements			
25	50			50	70	100	130
18 - 27	15 - 37.5			27 front 20 back	30.5 front 23 back	37 front 27 back	40 front 30 back
9 - 34	21 - 30.5	24 - 35.5	26 - 44	26	32	40	45
27 - 38	31.5 - 51	34.5 - 51	41 - 57.5	60 total back	69 total back	74 total back	80 total back
16.5 - 32.5 (Fixed Angle Foot Support) 11.5 - 36 (Flip Up Foot Support)	19.5 - 27	23 - 35	25 - 40.5	24 to floor	26 to floor	28 to floor	30 to floor
Wooden Base: 20° posterior Y Base: 10° anterior - 30° posterior	10° anterior - 30° posterior			Use wedge underneath			
- 15° - +15°	- 15° - +15°			x			
✓	✓			x			
28.5 - 75	29 - 76	33 - 76	36.5 - 76	N/A			
Hydraulic Foot Pump	Hydraulic Foot Pump			N/A			
✓	✓			✓			
Mild/Moderate/Complex	Mild/Moderate/Complex			Mild/Moderate/Complex			

Medifab is as diligent as possible in compiling this information. Medifab does not guarantee the correctness and completeness of the information provided. Equally, Medifab does not guarantee that this information is up to date. For questions concerning our products, their specifications and their utilisation please refer to the instruction manual and/or a product consultant of Medifab. Product specifications are subject to change without notice.

* Indicator only, for accurate product selection client measurements are the best guide.

Gravity Chair

Supportive foam positioning system to augment postural control for a wide range of individuals. The Gravity Chair follows the principle 'Tension and Relaxation' whereby it:

1. Provides alternative seating
2. Serves the therapeutical aim of stable positioning

More than just a comfortable seat...



Centre of gravity is very low to offer a stable seating position

Raised armrests 'bolster' the user laterally. This high armrest position facilitates free breathing to enable increased blood oxygen

Seating configuration **utilises gravity** to 'hold' the individual comfortably

Very light, which enables it to be used almost anywhere!



Standard configuration

- Removable and washable cover (choose either fully wipe-down or breathable inner section)
- Breathable seating insert (three liner colour options available: blue -066, green -055, red -022)
- Incontinence resistant sitting surface
- Headrest
- Hip belt
- Velcro® attached side pouch
- Wedge



Using the wedge accessory, the head and body position can be stabilised with tilt (including sideways tilt), for patients such as those with Scoliosis.

Size	Code	User Height	Seat Depth	Seat Width At Back	Seat Width At Front	Back Height	Chair Total Width	Chair Total Height	Chair Total Depth
Sml (1)	3770-00X1-XXX	90-110 cm	26 cm	20 cm	27 cm	60 cm	46 cm	55 cm	60 cm
Med (2)	3770-00X2-XXX	110-130 cm	32 cm	23 cm	30.5 cm	69 cm	49 cm	61 cm	71 cm
Lrg (3)	3770-00X3-XXX	130-150 cm	40 cm	27 cm	37 cm	74 cm	57 cm	66 cm	82.5 cm
XLrg (4)	3770-00X4-XXX	150-170 cm	45 cm	30 cm	40 cm	80 cm	60 cm	71 cm	91 cm

CLIENT GROUP

- Patients who can only lie down learn to be able to sit in the Gravity Chair.
- With patients who spasm, the Gravity Chair absorbs tension. After the spasm, the chair brings the user back into the original position.
- Patients with perception deficit or ADHD get close body contact in the Gravity Chair which raises self-awareness. This helps the user to stay calm. The Gravity Chair can create an optimal solution for many occupational therapy requirements.
- Palliative care



ACCESSORIES

Mobile Base

- 1 3780-8701-000
- 2 3780-8702-000
- 3 3780-8703-000
- 4 3780-8704-000



Therapy Tray

- Small**
3770-7101-000
- Large**
3770-7102-000
- Wide**
3770-7103-000



Supportive Headrest

- Occipital** 3780-4101-209
- Std. Lateral** 3780-4201-209
- Ext Lateral** 3780-4301-209



Indoor Bases for Stroller Seat Units

Height-adjustable indoor bases are available for the BINGO Mini, BINGO Evo, and BINGO Spex, where the removable seat units can be removed from the stroller base and attached to the indoor base with ease. Height-adjust features are quick and easy to change allowing the height of the seat to be lowered to the floor for peer interaction, raised to the dinner table to make mealtimes enjoyable for the whole family, or raised even further to breakfast bar height for easier feeding!

Cobra Base

Height-adjustable indoor base to suit the **BINGO Mini** (see page 14), **BINGO Evo** (see page 16), and **BINGO Spex** (see page 18) seat units.

German designed precision technology with a focus on quality and durability

45° of tilt

Simple and quick
Hand Operated Gas Assist height adjustment



Compact footprint for easy manoeuvrability and navigation around table legs



Lockable castors to stop the base from rolling

Size	Code	User Age	Max Load	Approx Product Weight	Tilt	Seat Height	Total Length	Total Width
1	2880-8711-000	1-5 years	50 kg	11.3 kg	45°	27-61 cm	71 cm	61 cm
2	2880-8721-000	3-15 years	50 kg	11.5 kg	45°	27-61 cm	71 cm	61 cm

Jenx Atom

Modern, child-centred styling, combined with a comprehensive range of support options make Atom the ideal seating system to develop correct seating posture and function.

A modular seating system for users 6 months - 5 years

Different **base options** with a variety of **fixed or adjustable heights** allow the flexibility for each child to enjoy activities from floor level to breakfast bar height



Tool free adjustments, cleverly designed wing knobs offer a comfortable grip to enable effective clamping with minimal effort

Unrivalled seat depth growth to accommodate early intervention requirements

Open sides ensures adjustments are easily made with the user remaining seated

Memory foam ischial well designed to nestle the pelvis. Provides comfort, pressure distribution and stability to promote correct pelvic alignment

Y-Base

- Versatile and flexible, with lockable swivel castors
 - High-low range of 25.8-75 cm seat height from floor
 - Tilt from 30° recline - 10° prone
 - Base footprint of 65 x 78 cm
- 3615-8740-000



FUNCTIONAL BENEFITS

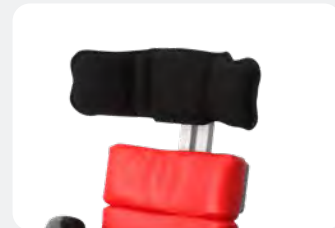

Head Positioning

Through our innovative Multigrip Head Supports, we offer a number of solutions that adapt to changing head positioning needs.



Trunk Positioning

All trunk positioning accessories are optional and are intended to offer just the right level of support.



Leg Positioning

With a number of different control options windsweeping, abduction and adduction can be easily influenced or controlled using our standard leg positioning accessories.



Foot Positioning

The child's feet can be precisely positioned using a number of standard accessories.

Code	Approx Age Range	Max User Weight	Tilt	Back Pad Height	Chest Width	Hip Width	Seat Depth	Lower Leg Length	Foot Support Angle
3431-0001-022	6mths - 5yrs	25 kg	15° - 15°	27-38cm	20-28cm	18-27cm	9-34cm	16.5-32.5cm	5° - 35°

Accessories

Wooden Base

High 3431-8720-000
Low 3431-8710-000



Multigrip Head Support

1 Link 3431-4601-022
2 Link 3431-4602-022
3 Link 3431-4603-022



Shoulder Protractors

3431-2750-022



Lumbar Pad

3431-2501-000



Back Pad Infill

3431-2370-000



Thoracic Support Pads

High-Rise 3430-3151-000
High-Rise Flexible 3431-3251-022



Arm Supports

3431-5501-000
Arm Support Covers 3431-5510-022



Waistcoat Anterior Chest Support

3615-6701-000



Nursery Tray 3431-7101-022

Infill 3431-7182-000
Half Padding 3431-7442-000
Full Padding 3431-7452-000



Elbow Blocks

3730-7350-000



Activity Frame

3615-7475-000
Grab Rail 3615-7200-000



3 Point Lap Strap

3431-6251-000
Spex 4 Point Lap Strap 1406-6420-027



Abduction Block

0 3615-1650-000
1 3615-1651-000



Long Leg Sitting Board

3431-0281-022



Leg Control Pads

3431-1751-000



Fixed Angle Foot Support

3431-5302-000
Flip Up Angle Foot Support 3431-5301-000



Foot Support Pad

3431-5701-000

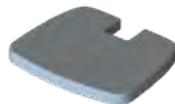

Sandals

5356-6081-000



Ankle Snugs

5356-6131-000



Sandal Raising Blocks

5356-6091-000



Jenx Junior+

Comfortable, contoured and stable modular seating system, designed for children with mild to complex posture support needs. Outstanding levels of adjustment with a wide variety of support options.

Functionality, flexibility and style

Carefully designed to draw attention to the child rather than the equipment itself



Pelvic control system with independently adjustable contoured seating

Flip-up angle adjustable foot support to accommodate dorsi or plantar flexion

All support pads and accessories are designed to quickly & easily flip away without being removed



Y-Base

- Versatile and flexible, with lockable swivel castors
- High-low range of 25.8-75 cm seat height from floor
- Tilt from 30° recline - 10° prone
- Base footprint of 65 x 78 cm

3615-8740-000



Low seat-to-floor height for peer interaction.



Ease of transfer with tilt and swing-away supports.



Open design for comfort and support.

ACCESSORIES

Multigrip Head Support
 1 Link 5356-4601-000
 2 Link 5356-4602-000
 3 Link 5356-4603-000



Waistcoat Anterior Chest Support
 Size 1 3615-6701-000
 Size 2 3615-6702-000
 Size 3 3615-6703-000



Abduction Block
 1 3615-1650-000
 2 3615-1651-000
 3 3615-1652-000



Shoulder Protractors¹
 1 3612-2750-000
 2 3612-2751-000
 3 3612-2752-000



Lateral Trunk Supports¹
 Short 1 3610-3151-000
 Short 2 3615-3152-000
 Flexi 1 3615-3251-000
 Flexi 2 3615-3252-000
 Flexi 3 3615-3253-000



Tray²
 Junior 1 3615-7101-000
 Junior 2 3615-7102-000
 Multiseat 3614-7103-000



Tray Infill
 1 3610-7180-000
 2 3610-7182-000



Tray Elbow Blocks
 3615-7350-000



Angle Adjustable Push Handle
 3612-8610-000



Activity Frame
 3615-7475-000



Size	Code	Approx Age Range	Max User Weight	Back Angle	Seat Depth	Hip Width	Back Support Height	Back Support Height With Extension	Lower Leg Length	Base Option
1	3612-0001-000	18 mths-5 yrs	50 kg	15° recline - 15° prone	21-30.5 cm	17-37.5 cm	31-41 cm	31-48.5 cm	19.5-27 cm	Y-Base
2	3612-0002-000	3-8 yrs			24-32 cm		33-43 cm	33-50.5 cm	25-36.5 cm	
3	3612-0003-000	5-12 yrs			27.5-39 cm		39-52 cm	39-59.5 cm	25-40.5 cm	

Size 4 is Launching Soon







Therapy



Use versatile therapy aids for your child to create play opportunities, provide support and rest, use for specific therapy treatments, and for the promotion of activities such as crawling, sitting, and balancing.

Jenx Corner Seat	38
Jenx Nursery Table & Therapy Bench	39
Jenx Ly-on	40
Kid'in'form Ultimate Kit/Positioning System	42

Jenx Corner Seat

Bright, comfortable and ideal first seat for any child, which also suits infants and young children. Offers support in long sitting, which is children's usual first sitting position.

Adjustable floor based seating system

Sturdy wings and corner shape helps to **maintain a midline position** with symmetry of the child's spine



Adjustable Height Back Support can be used with or without the upper back support to support head or shoulders

Abduction Block helps keep the child well positioned, with their hips neatly back into the seat

Small 'touch and close' tape straps keep the Corner Seat **safely connected** to the nursery table while in use

Sitting Benefits

- Long sitting, with the legs stretched out in front, helps to maintain the length of the muscles behind the knee.
- Great working space for peer group interaction and plenty of fun activities including working and playing with other children.



NURSERY TABLE

- Effective when used together with the Corner Seat.
- Large plastic play/activity surface which can be used flat, angled or as an easel.
- Continuous height adjustment to allow the precise and correct height.
- A short strap attaches to the Corner Seat to prevent a child tipping the table over.
- Easy to wipe clean, with cut out to allow the child to get close to the tabletop activities.
- Bright and contrasting edging around the surface reduces the risk of objects sliding off and provides a place for toys to be secured to.



See opposite for codes and sizes.

ACCESSORY

Triangular Cushions

For when a flat back with wings is preferred. Fit all seat sizes. Can also be used beside legs to prevent external rotation.

Lime
3140-2450-054

Blue
3140-2450-066



Size	Code	Approx Age Range	Back Pad Height	Seat Depth	Max User Weight	Base Size	Colour
1	3140-0041-054	6 mths - 2 yrs	31.5 - 42.5 cm	35 cm	25 kg	49 x 50 cm	Lime
2	3140-0042-054	1-6 yrs	44 - 62 cm	37 cm	35 kg	52 x 54 cm	Lime
3	3140-0044-066	4-10 yrs	50 - 68 cm	46 cm	55 kg	60 x 63 cm	Blue

Jenx Nursery Table

Effectively used in conjunction with the Jenx Corner Seat and Jenx Therapy Bench, the Jenx Nursery Table is available in three sizes to suit children from 9 months to 6 years old.

Adaptable Work Surface

The **height adjustable surface** can be used flat, angled or as an easel



The **large surface** is big enough for play or work activities

The smooth, sturdy and **wipe clean surface** is ideal for drawing and writing activities

Versatile table can be paired with Corner Seat or Therapy Bench

USED IN CONJUNCTION WITH CORNER SEAT



Size	Code	Base Size	Table Top Angle Range	Table Top Size	Table Height
0	3140-7101-000	60.5 x 38 cm	+40° to -40° from horizontal	51 x 60.5 cm	19-28 cm
1	3140-7102-000	60.5 x 38 cm		51 x 60.5 cm	24.5-34.5 cm
2	3140-7103-000	70 x 42 cm		51 x 70.5 cm	29-44 cm

Jenx Therapy Bench

Ideal platform for a variety of different activities such as sitting and balance therapy, dynamic sitting balance and sitting posture improvement

Therapy aid designed to promote upright sitting and balance

Easily **height adjustable** using tightening bolt



Easy to clean, antimicrobial, wipe-down vinyl cushions

Interchangeable cushions include the standard 1" flat cushion and the half round cushion

The simple design means that the Therapy Bench can be **easily moved** with just 1 hand

ACCESSORIES

Half Round Cushion
Size 1 7510-0501-054
Size 2 7510-0502-054

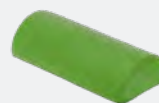

Pelvic Support
7510-1900-054



Abduction Block
7510-1750-054



Knee Blocks
Size 1 7510-1601-054
Size 2 7510-1602-054



Size	Code	Max Load Weight	Bench Height from Floor	Bench Top Length	Bench Top Width	Flat Cushion Width	Flat Cushion Length	Flat Cushion Depth
Size 1 - Full Length	7510-0010-054	85kg	165-250 mm	980 mm	200 mm	250 mm	1000 mm	25 mm
Size 1 - Half Length	7510-0015-054	85kg	165-250 mm	480 mm	200 mm	250 mm	500 mm	25 mm
Size 2 - Full Length	7510-0020-054	85kg	235-395 mm	980 mm	250 mm	300 mm	1000 mm	25 mm
Size 2 - Half Length	7510-0025-054	85kg	235-395 mm	480 mm	250 mm	300 mm	500 mm	25 mm

Jenx Ly-on

Modern, child-centred styling, combined with a range of accessories make Ly-on the ideal platform to build a structured yet safe and comfortable posture for children with complex postural or medical needs.

Feeding, Education and Access Station for users up to 70kg

Activity Frame and Tablet Holder easily clip into place allowing the user to be entertained during long periods of lying.

Standard with a wide range of height adjustment – supporting children to engage in low to the floor activities whilst also being able to be correctly positioned for even the tallest of carers

15° tilt recline and forward allows for weight distribution to be altered to aid in pressure management.



Side Lying Straps offering controlled positioning at the chest or pelvis.

Fold down sides, allowing for easy engagement with the child and also making transfers in and out of Ly-on safe and dignified.

Removable and washable at 60°, this accessory sheet allows for precise positioning of the various support options.

STANDARD PACKAGE INCLUDES

- 4 braking castors - one of which is directional lockable to aid in manoeuvrability
- Hydraulic lift action
- Tilt-in-space mechanism
- Fold-down side rails
- 4 Side Walls in green vinyl - 250mm high
- End bumpers in green vinyl
- Memory foam topped lying surface (covered with grey wipe clean PU material)
- 1 Hook Receptive Sheet
- 10 Hook Tabs to hold Hook Receptive Sheet in place
- Push handle



Activity Frame/
Tablet Holder



Height Adjustable
Platform



Support Blocks
and Straps



Hooks and Loop
Receptive Sheet



Fold Down
Sides



Code	Max. User Weight	Max. User Height	Tilt	Support Platform Dimensions	Side Wall Height (3 sizes available)	Foot Support Dimensions	Height From Floor	Product Weight
7520-0015-054	70kg	160cm	15°- 15°	168 x 56cm	20/25/30cm	196x 67cm	52-101cm	76kg

Accessories

Extra Hook Receptive Sheet
7520-7000-000



Extra Hook Tab
7520-7050-000



Side Wall:
Size 1: 7520-7211-054
Size 2: 7520-7212-054
Size 3: 7520-7213-054



Side Lying Strap:
Size 1: 7520-1871-000
Size 2: 7520-1872-000
Size 3: 7520-1873-000



Rotation Control Strap:
Size 1: 7520-1881-000
Size 2: 7520-1882-000
Size 3: 7520-1883-000



Rotation Control Frame
7520-1870-000



Accessory Mount
7520-7925-000



Activity Frame:
Size 1: 7520-7911-000
Size 2: 7520-7912-000



Tie-on Beam
7520-7920-000



Tablet Holder
7520-7930-000



Triangular Shelf Block
7520-7750-000



Triangular Positioning Block
7520-1850-000

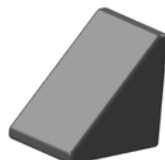

Bridge Block:
Size 1: 7520-7441-000
Size 2: 7520-7442-000
Size 3: 7520-7443-000



Half Roll Block:
Size 1: 7520-7821-000
Size 2: 7520-7822-000

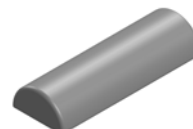

Roll Pillow
7520-7800-000



Flat Oval Pillow
7520-7500-000

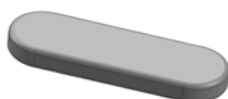

Accessory Cart
7520-7950-000



Accessory Box
7520-7940-000



Kid'In'Form Ultimate Kit

- Includes 2 small cylindrical rolls, 2 medium cylindrical rolls, large cylindrical roll, 2 extra-small cylindrical rolls, pierced cushion, medium belt strap, large belt strap, back support and comfort mat.
- Wide variety of positioning accessories allows flexibility of positioning options.
- If using in multi-user environments, will suit more users with increased sizes and options.



	Ultimate Kit
Code	7008-0003-279

Kid'In'Form Positioning System

- Introductory lying and positioning system for early intervention. Portable and adaptable, with simple supports to facilitate active sitting, supine and prone positioning.
- Use the complete kit or components of the system to achieve the desired supported position.
- A versatile option for occupational therapists and physiotherapists who need to position the child securely in order to practice exercises or for stimulation/ therapy.
- Can also be used by parents and caregivers at home to offer positioning options to the child alternative to rigid positioning systems. Parents can position their child in a wide range of positions, to stimulate them and encourage perception of their surroundings.
- Recommended in the child's discovery and exploration phases and for directed practical work due to the following benefits:
 - Fabric covers feel pleasant to children and meet requirements of sensory tactile stimulation.
 - Different designs allow set-up of psychomotor exercises, to securely place the user and to offer a safe and relaxed environment.
 - Flexibility of the system encourages creativity and enables positions to be set for the child (to encourage protraction of the shoulders, to get down on hands and knees, to sit up, and more).



	Dimensions	Component
Extra-small cylindrical rolls	Ø 8 x 10 cm	
Small Cylindrical Roll	Ø 8 x 20 cm	
Medium Cylindrical Roll	Ø 8 x 70 cm	
Large Cylindrical Roll	Ø 11 x 50 cm	
Medium Belt Strap	60 x 14 cm	
Large Belt Strap	80 x 14 cm	
Backrest	76 x 24 x 17 cm	
Pierced Cushion	25 x 25 x 5 cm	
Comfort Mat	140 x 76 cm	



Making travelling easy and safe



Vehicle Seating



Some passengers with disabilities require support to keep them upright and safe. Others with challenging behaviours need control to prevent them from escaping from the vehicle seat and causing danger. Others with challenging behaviours need support to maintain their safety as well as others they are traveling with.

Car Seats

Carrot 3000 Car Seat	46
Carrot XL Car Seat	48
Hero Car Seat	50
Starlight Car Seat	51
Ipai Car Seat	52

Vehicle Harnesses

Houdini Harnesses	54
Walking Rein	58

Carrot 3000 Car Seat



Various extension accessories and multi-adjustable features allow for growth and adaptation as a child's needs change over time. The Carrot 3000 caters for safety and the importance of keeping the child in a supported posture for travel.

Our most comprehensive special needs car seat

Basic package includes

- Carrot seat unit
- 5-point anterior chest support
- Headrest wings
- Tee-pad
- Free recline back support

Ergonomically designed **head support** holds the head and protects from side impacts and centrifugal forces

Tether options include additional security tether for the top of back support or ISOfix latch connectors.

2 positions of **seat depth adjustment** for a better fit



Shoulder protector wings: Extendable wings hold and protect the body from side impacts and centrifugal forces

Large **chest support** holds the body securely

Recline function with angle adjustable seat and back support



Huge growth for pre-schoolers to older children

When requesting quote, please specify the user's shoulder height and seat depth.



Size	Code	Age Range	User Weight Range	Seat Depth	Seat Width	Shoulder Height	Foot Support Height	Seat Weight
Small	4116-0010-259	3-15 years	15-36 kg	25-40 cm	31cm	32-52 cm 45-67 cm * (*when shoulder protector wings are added)	Small = 25-30 cm Medium = 30-40 cm Large = 40-50 cm	8.7 kg

The Carrot 3000 conforms to EU (ECE R44/04) standards.



Large chest pad/head support model available (4116-0000-259)



If user is too large for the Carrot 3000 Car Seat, the Carrot XL Seat (4116-0020-259) is available for larger users. See page 48



Air Travel Friendly

The Carrot 3000 Car Seat has been approved for use in aircraft of some major airlines including the Federal Aviation Administration in the USA. This is NOT a guarantee that your chosen airline will allow the Carrot 3000 Car Seat to be used in their aircraft, and you must contact the airline prior to flying.

Accessories

Swivel Base Attachment*
 4116-0180-104
Swivel Base Protection Plate
 4116-0190-000



* Requires ISOfix

Foot Support
Sml lower leg (D): 25-30 cm
 4116-5241-250
Med lower leg (D): 30-40 cm
 4116-5242-250
Lrg lower leg (D): 40-50 cm
 4116-5243-250



Swivel Base Floatplate Adaptor
 4116-5120-000



Seat Belt Holder
 4116-6790-017



Removable Incontinence Cover
 4116-0475-209



**Rodded 50mm
 Seat Depth Pad**
 4116-0281-259

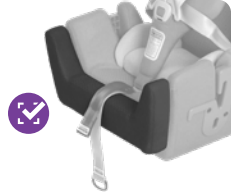

**100mm Rodded Waterfall
 Seat Base Extension**
 4116-0283-259

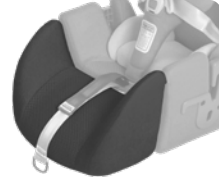

**50mm Seat Depth
 Growth Pad**
 4116-0285-259



**100mm Seat Depth Growth
 Pad (only with Waterfall)**
 4116-0289-259

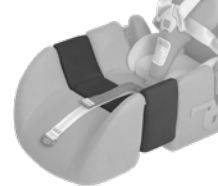

Abduction Pad
 4116-1510-000



**50mm Back Support Height
 Extension Infill Pad**
 4116-2481-259



**100mm Back Support Height
 Extension Infill Pad**
 4116-2482-259



Shoulder Protector Wings
 4116-2753-259



**Anti-Escape Anterior
 Chest Support**
 4116-6026-259



Shoulder Strap Retainer
 Small: 4116-6721-000
 Medium: 4116-6722-000
 Large: 4116-6723-000



**Pen Release Anterior
 Chest Support**
 4116-6025-259



**Cross Strap Anterior
 Chest Support**
 Anti-Escape 4604-3004-026
 Pen Release 4604-3004-025
 Side Release 4604-3112-019



Tether Strap
 4116-6953-017



ISOfix Lower Straps
 4116-6910-000



Hinge Lock Belt
 (for easy carrying)
 4116-8170-000



Tray / Forearm Support
 4116-5534-259



Tilt Wedge
 4116-0291-259



**Firm Contoured Lateral
 Trunk Support Wedges**
 4116-3250-090



Air Mesh Cushion Pad
 4116-8880-099



Carrot XL



Carrot XL caters for safety and the importance of keeping the user in a supported posture for travel. This larger sized car seat is suitable for older children and adult users who will not fit into the Carrot 3000.

Larger version of the popular Carrot 3000 Car Seat



Extendable shoulder protector wings hold and protect the body from side impacts and centrifugal forces

Ergonomical large head support

Special **large anterior chest support** design with easy length adjustment to support the shoulders of older users

Correct **pelvis alignment** with comfort padded hip belt

Low profile **wide seat base**

UPGRADE KIT

Upgrade an existing Carrot 3000 to XL

Carrot XL Upgrade kit can be purchased to **upgrade an existing Carrot 3000 Car Seat** to an XL version, instead of purchasing a whole new car seat when the child grows out of the existing seat.



Kit includes:

- XL Low profile wide Seat Base
- Longer metal rods for base
- H-Anterior Chest Support
- Hip belt

4116-0030-259

Please note that the XL Upgrade Kit must be fitted by Medifab Ltd or an authorised Medifab distributor.

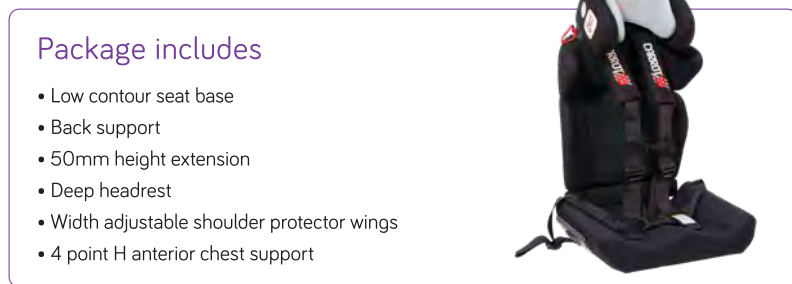

Package includes

- Low contour seat base
- Back support
- 50mm height extension
- Deep headrest
- Width adjustable shoulder protector wings
- 4 point H anterior chest support

FUNCTIONAL BENEFITS

- Equipped as standard with the low profile wide seat base, large size headrest, shoulder protector wings, and 50 mm back support extension.
- Extendable shoulder protector wings hold and protect the body from side impacts and centrifugal forces.
- Tether options include additional security tether for the top of back support or ISOfix latch connectors. These may be required by your local authorities.

If user is too small for the Carrot XL Car Seat, the Carrot 3000 Car Seat is available for smaller users. See page 46

The Carrot XL conforms to EU (ECE R44/04) standards.



Code	Age Range	User Weight Range	User Height Range	Seat Depth	Seat Width	Shoulder Height	Seat Weight
4116-0020-259	10 to Adult	36-75kg	140cm - 175cm	38 or 42cm	48cm	32-52 cm or 45-67 cm*	10.5kg

*When Shoulder protector wings added.

Accessories

Tether Strap
4116-6953-017



ISOfix lower straps
4116-6910-000



Anti Escape Anterior Chest Support Options



Tilt Wedge
4116-0291-259



100mm Back Support Height Extension Infill Pad
4116-2482-259



Forearm Support Tray
4116-5544-259



Lateral Trunk Supports
4116-3250-090



Air Mesh Cushion Pad
4116-8880-099



Hipbelt (Seat Base)
Medium 4116-6532-027
Large 4116-6533-027



XL Upgrade Kit For Existing Carrot 3000 Car Seat
4116-0030-259



Crotch Belt
(requires customisation of seat base)
4116-6320-000



Hero Car Seat

The Hero child car seat is a specifically modified car seat to accommodate the postural requirements of children with additional needs. It is suitable for installation in most commercially available vehicles that have an ISOFIX connection. The car seat is designed for use on the back seat of a car, and with the ISOFIX anchorage system providing a secure attachment to the vehicle, it does not have to be fastened with the car seat belts, guaranteeing easy handling.

Swivelling car seat for forward or rear-facing



Swivel by 90° so that the child can be seated in the car seat without straining the parent or caregiver's back

5-point-harness with upholstery, height adjustable

Belt mechanics installed into the front of the seat

Large seat recline

Height adjustable back support and head supports

360° swivel base with adjustable footwell stilt

ACCESSORIES

Security Tray
4181-5530-000



FUNCTIONAL BENEFITS

- Switch the Hero around for either forward or rear facing. The Hero can be used both forward and rear-facing direction.
- To support children with limited upper body control, the Hero has a tilt function to adjust the seat angle.
- The Hero is equipped with its own 5-point chest and shoulder strap that securely holds your child in place.

Package includes

- Available in Black/Red
- 10° tilt with swivel base 360°
- Rear/Forward facing position
- Five-point harness
- Back Support Height Adjustable
- Lateral Supports as standard

Practical and functional



In direction of travel; adjustable back height



Rotatable by 90°, 180° or 360° for ease of transfers



In rearward position



Lateral Supports fitted as standard

Code	Seat Width (knee)	Seat Width (pelvis)	Seat Depth	Back Height	Crown Height	Distance Laterals	Total Height	Total Width	Total Depth	Capacity
4181-0010-020	280 mm	210 mm	250 mm	210 mm	410 mm	120 mm	660 mm	430 mm	630 mm	18 kg
				340 mm	530 mm	210 mm	730 mm			

*Measurements with standard cushion

Starlight Car Seat

Fully adjustable special purpose car restraint, offering excellent posture support options and an inbuilt tilt function. Starlight is suitable for young children from 9kg, and will grow with the child right up to 36kg.

Excellent postural support

Inbuilt adjustment to the rear of the seat allows the backrest height to be increased for growth

Large abdominal pad **protects child** at harness buckle

Crash tested to ECE R44-04



Uses **vehicle seatbelt** to secure the child

5 point comfort harness with shoulder and abdominal padding, and centre pull adjuster

ACCESSORIES

Forearm Support Tray
4141-5530-000



Abduction Pommel
4141-1510-000



Inbuilt Cup Holder

Package includes

- Adjustable headrest
- Backrest infill padding
- Slim lateral supports
- 20° tilt
- Base board accessory
- Swivel base system - (Left turning) to enable turning of the car seat towards the doorway to help with transfers
- ISOFIX seat attachment
- Grey/Black upholstery



SLIM SWIVEL BASE

Allows more space and headroom inside the car when turning out.



Left Turning Swivel Package: 4141-0011-090

Code	Seat Width (pelvis)	Seat Width (knee)	Seat Depth (min-max)	Back Height	Crown Height	Height Laterals	Distance Laterals	Car Seat Weight	Capacity
4141-0011-090	30cm	35cm	26cm	27-39cm	51-62cm	17-27cm	14-19cm	8.5kg	9-36kg

*Reducer cushion available

Ipai LGT Car Seat

The Ipai LGT lives up to its name, characterised by a light weight easy-to-use design and provides mild body support and care for children with additional needs. Comes standard equipped with ISOFIX, thoracic supports and a 5-point harness that is padded at the shoulders. As part of the supportive harness a large, stable tee pad guarantees firm support across the child's pelvis.

Light weight, comfortable and safe!



Side Impact Protection System

Simple height adjustment providing comfort and safety

Integrated ISOFIX for easy installation

5 point comfort harness comes as standard

ACCESSORIES

Ipai LGT Padded Tray Table
4080-5411-000



FUNCTIONAL BENEFITS

- Simple height adjustment function allows the backrest 20cm of height range providing greater comfort and safety for the child.
- Easy release ISOFIX attachment makes Ipai LGT a breeze to install in any ISOFIX compatible vehicle. Please note, the vehicle seat belt must be used in conjunction with the car seat.
- Have the peace of mind that your child is kept safe with the Side Impact Protection System that can be unscrewed to secure the car seat against the side of the vehicle door, improving safety in the event of side impact to the vehicle.

Package includes

- Available in Black
- Five-point harness
- Backrest height adjustable



Backrest Height



ISO Fix



Side Impact Protection System



Code	Seat Width (rear)	Seat Width (front)	Seat Depth	Back Height	Head Support Height	Lateral Support Height	Distance between Laterals	Back Support Recline Angle	Total Height	Overall Width	Total Depth	Total Weight	Capacity
4081-0011-060	31 cm	34 cm	32 cm	38-58 cm	59-79 cm	20-33 cm	14-28 cm	85°- 162°	67-85 cm	48 cm	39 cm	7 kg	36 kg

Medifab Vehicle Harnesses

Medifab has had many years of experience with providing solutions for passengers who require support or management during travel. Passengers with disabilities require additional control to keep them upright and safe, and other individuals with challenging behaviour require a type of control that will prevent them from escaping from the vehicle seat and causing danger.

Houdini Harness Checklist	
Question	Product Suggestion
Does your client require a vehicle harness for intellectual disability (to prevent escaping)	All models appropriate. Use the shoulder cross strap to prevent the straps slipping off the shoulders if necessary.
Does your client require a vehicle harness for physical disability (to provide additional posture support)	Model 27 or 28 Ask us for a standard vehicle press-release buckle if necessary.
Level of client motor skills or coordination: (for clients requiring escape proof buckles) <ul style="list-style-type: none"> • Very fine • Limited • No fine motor skills 	<ul style="list-style-type: none"> • Very fine – Ask us regarding an upgrade to a pen/key release system. • Limited – Use the Metal Anti-Escape buckle (comes standard on Models 27, 28 and 31). We also recommend the shoulder cross strap used in conjunction with the harness of choice. • No fine motor skills – Ask for a standard vehicle press-release buckle if necessary.
Is the harness going to be installed on a: <ul style="list-style-type: none"> • Single seat (e.g. front seat or 1 person back support) • Bench seat • Deep contoured single seat 	<ul style="list-style-type: none"> • Single seat – Models 13, 22, 27, 28, or 31. • Bench seat – Models 22, 28, or 31. • Deep contoured single seat = Model 22 or 28.
What vehicle is the harness going to be installed in: <ul style="list-style-type: none"> • Taxi (e.g. for school travel) • Using in multiple vehicles • One vehicle only 	<ul style="list-style-type: none"> • Taxi – Models 22, 28, or 31. • Using in multiple vehicles – Model 22 • One vehicle only – Any harness from the range.

Vehicle Seating

Frequently asked questions

Are these harnesses NZ/AU safety approved?

No. There is no certification. These harnesses are a 'positioning' device only, not a safety device.

Do I require a tether point attachment?

No. The harnesses are simply strapped to the existing vehicle seat.

Can I use the harness on an aeroplane?

Yes, however you must get written permission from the airline prior to departure.

What do I do if there is no access behind the seat for the attaching straps, i.e. in the back seat of a sedan vehicle?

Cut some small slots in the rear carpet flap so the attaching straps can be threaded through (the parcel shelf may have to be removed).

These are not safety harnesses and must be worn in conjunction with the vehicle safety belt.

Vehicle Harness Comparison Chart



Specifications	HOUDINI 13		HOUDINI 22		HOUDINI 27	
	13J	13H	22C	22D	27A	27B
DESCRIPTION	All buckles are behind the seat so user cannot release them.		Popular option for taxis. Body section attaches to user before entering the vehicle. Multiple seat straps can be purchased.		Full 5 point harness for more postural control. For single back support seat only.	
APPROX AGE OF USER*	3-8 yrs	7-Adult	3-8 yrs	7-Adult	3-8 yrs	7-Adult
GAP REQUIRED BETWEEN SEAT & BACK SUPPORT?	✓	✓	✓	✓	✗	✗
CAN BE FITTED TO USER BEFORE ENTERING THE VEHICLE	✗	✗	✓ 2 piece harness. 2nd piece stays in vehicle		✗	✗
SINGLE SEAT COMPATIBLE	✓ (Not suitable with built in headrest)		✓		✓	
BENCH SEAT COMPATIBLE	✗		✓		✗	
COMMENTS	To fit the harness easy access is required all the way round the seat back and underneath the base of the seat cushion.		The body harness is worn before entering the vehicle. It is fitted with a waist belt and chest strap which fasten behind the passenger's back with side-release buckles.		Can offer postural support and assist in seating the occupant in an upright sitting position for those with physical disabilities where extra support and positioning is required during travel.	
BUCKLE TYPE**	Std../AE/PP		AE/PP/MAG.		AE/Std../PP	
BOOSTER SEAT	✓		✓***		✓***	
RESTRAINT LEVEL	Mild		Moderate/High		Moderate	
FIXING TYPE	Buckles connect around rear of seat.		Vertical fixing straps installs to vehicle seat first		2 horizontal straps connect to vehicle seat.	

* Indicator only, for accurate product selection client measurements are the best guide.

** AE = Anti-escape PP= Pen/Key Release Std.= Push Button Mag.= Magnetic Upgrade

*** Booster seat base unit only. Harness cannot be incorporated with full back support/seat booster.

Medifab is as diligent as possible in compiling this information. Medifab does not guarantee the correctness and completeness of the information provided. Equally, Medifab does not guarantee that this information is up to date. For questions concerning our products, their specifications and their utilisation please refer to the instruction manual and/or a product consultant of Medifab. Product specifications are subject to change without notice.



HOUDINI 28	HOUDINI 31	
28	31A	31B
Same as Model 27, however this popular version is designed for bench vehicle seats.	Most secure harness. 7 point control with bib front to secure the torso effectively.	
7-Adult	3-8 yrs	7-Adult
✓	✓	✓
✗	✗	✗
✓	✓	
✓	✓	
Very popular harness. This Houdini 28 harness is similar to the Houdini 27 except that the seat attachment straps go vertically around the vehicle seat.	Offers greater support due to a front PVC pad that is attached around the individual's torso with two straps fitted with anti-escape buckles.	
AE/Std.../PP	AE/PP/MAG.	
✓ ***	✓ ***	
Moderate	High	
2 horizontal straps connect to vehicle seat.	2 horizontal straps connect to vehicle seat.	

Houdini 13 Harness

- Can be fitted on **wheelchairs and some easy chairs** as well as using in vehicles
- All buckles are **behind the seat** so the user cannot release them.



Model	Code	Age Group	Buckle
13J	4604-1302-017	3 to 8 years	Anti-Escape
13H	4604-1303-017	7 yrs to Adult	Anti-Escape

MODEL 13 BENEFITS

Suitable for use with people who are confused or have challenging behaviour, as all the buckles are behind the seat back.

In vehicles, this harness is suitable for use on a **single seat only**, and requires a gap between the vehicle seat and back support for installation.

Not a safety harness: must be worn in conjunction with vehicle safety belt.

Upgrade all 3 buckles (neck strap and 2 on waist band)
Pen/key release 4604-1305-031

Houdini 22 Harness

TAXI

- Can be used on **single or bench seats**
- Fit to the user **before entering vehicle**
- Good option for **taxi's** and also suitable for hip spicas.



Model	Code	Age Group	Buckle
22C	4604-2211-017	3 to 8 years	Anti-Escape
22D	4604-2212-017	7 yrs to Adult	Anti-Escape

MODEL 22 BENEFITS

Consists of a removable torso section which is attached to the individual prior to entering the vehicle.

Once the individual is seated, two buckles are engaged to provide safe travel.

Not a safety harness: must be worn in conjunction with vehicle safety belt.

Additional seat attachment strap for use in another vehicle
4604-2222-017

Upgrade all 4 buckles (crotch strap, upper neck strap and 2 on waist band):
Pen/key release 4604-2215-031

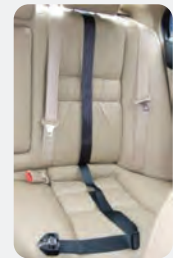

Houdini 27 Harness



- **Centre-release buckle** to provide postural support, **anti-escape** to prevent removal
- Attachment straps **fasten horizontally** around seat
- Suitable for single back support seats and **air travel***



Model	Centre-Release Buckle	Anti-Escape	Age Group
27A	4604-2702-017	4604-2702-026	3 to 8 yrs
27B	4604-2703-017	4604-2703-026	7 yrs to Adult

MODEL 27 BENEFITS

Designed to offer postural support and a certain degree of restraint as it is a full 5-point harness. Identical to Houdini 28; however straps fasten horizontally (28's fasten vertically).

Only suitable for single-backed seats.

Not a safety harness: must be worn in conjunction with vehicle safety belt.

Upgrade buckle on waist belt:
Pen/key release 4604-2805-031

* Signed approval must be obtained from the airline prior to travel.

Houdini 28 Harness

- Medifab's **most popular** model of Houdini Harness
- Attachment straps **fasten vertically** around seat
- **Centre-release buckle** to provide postural support, **anti-escape** to prevent removal.



Model	Code	Age Group	Buckle
28	4604-2803-017	Junior to Adult	Centre-Release
28SB	4604-2803-026	Junior to Adult	Anti-Escape

MODEL 28 BENEFITS

Designed to offer postural support and a certain degree of restraint as it is a full 5-point harness. This harness is the same as the Model 27, however the seat attachment straps go vertically around the vehicle seat.

This is suitable for **single or bench seats**. For seats that 'narrow' towards the top of the back support, the Model 27 is more suitable.

Not a safety harness: must be worn in conjunction with vehicle safety belt.

Upgrade buckle on waist belt:
Pen/key release
 4604-2805-031

Houdini 31 Harness

- **Most secure harness**, with twin anti-escape buckles
- Can be used on **deep 'bucket' single or bench seat**.
- Can be fitted to some regular booster seats - if straps can be attached to back support



Model	Code	Age Group	Buckle
31A	4604-3101-017	3 to 8 yrs	Anti-Escape
31B	4604-3102-017	7 yrs to Adult	Anti-Escape

MODEL 31 BENEFITS

This harness offers more support due to a front PVC pad that is attached around the individual's torso with two straps fitted with anti-escape buckles.

Not a safety harness: must be worn in conjunction with vehicle safety belt.

Upgrade both buckles on waist band:
Pen/key release 4604-3105-031

CROSS STRAP

Fit to a harness to hold shoulder straps together & prevent them slipping off.

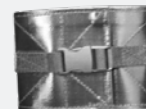

PVC with side-release buckle
 4604-3112-019

PVC with anti-escape
 4604-3004-026

PVC with pen release
 4604-3004-025



Cross Strap Padded Sleeve (side release buckle)
Sml 4604-3117-017
Lge 4604-3118-017



Designs and styles may vary.

BUCKLE OPTIONS



Anti-Escape

Successfully prevents those with inquisitive fingers, challenging behaviour or learning difficulties from releasing the buckle. Operates in reverse to normal, as it is disengaged by raising a spring-loaded lever and will not press release.



Pen/Key Release

Requires a tool such as a pointed pen or key to prod the buckle release mechanism to open. Medifab supply a release tool with each of these buckles.

Walking Rein

Curious individuals with challenging behaviour can suddenly slip out of your sight despite your best intentions. A walking rein will help you keep your loved ones close.

Help keep children and adults safe when out walking.

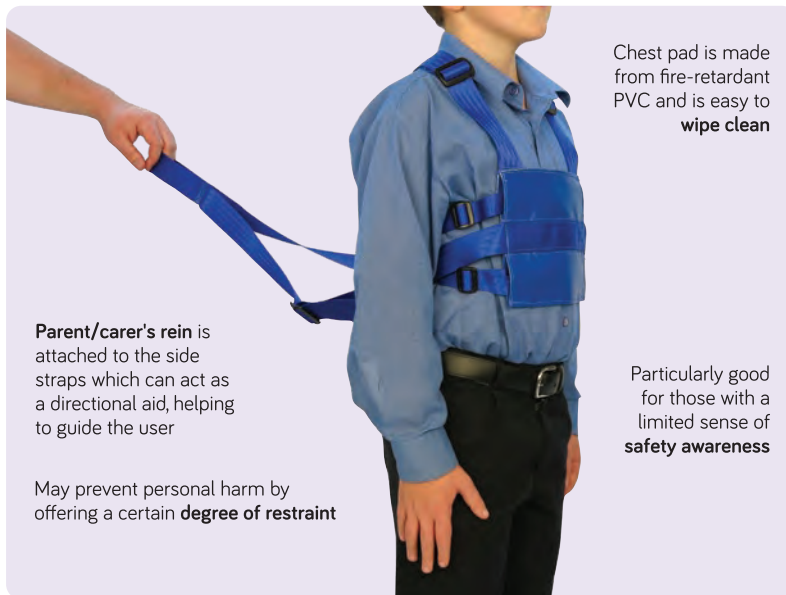

Parent/carer's rein is attached to the side straps which can act as a directional aid, helping to guide the user

May prevent personal harm by offering a certain **degree of restraint**

Chest pad is made from fire-retardant PVC and is easy to **wipe clean**

Particularly good for those with a limited sense of **safety awareness**



Ideal to use as a back-up safety method to keep someone within reach, especially during walks to the park where the dangerous roads are never far or in shopping centres where lots of people are distracting.

It is important for safety reasons that the rein strap is always held behind the child and not pulled from the front. This ensures the strain is on the very strong webbing belts and not on the PVC chest pad.

*Note: Never leave your child unattended. This product is not a substitute for proper adult supervision

VERSIONS AVAILABLE

STANDARD REIN

Has waist belt plus chest strap and detachable rein strap



ESCAPOLOGIST REIN

For the very active person. Fitted with a chest belt, waist belt and shoulder straps. Has adjustable and detachable rein.



Model	Code	Age/Size
Standard	4605-0062-017	Fits most ages, up to 97 cm waist circumference
Small Escapologist	4605-0065-017	Up to 8 yrs
Large Escapologist	4605-0066-017	9 yrs to adult







Standing Aids



From early intervention standing to older teens, find the solution that will keep your child in the optimum standing position depending on their unique needs.

Jenx Monkey Stander	64
Jenx Multistander	65
Jenx Multistander with Abduction	66
Jenx Standz Size 1	67
Jenx Standz Size 2	68
Jenx Supine Stander	70

Standing Frame Comparison Chart



SPECIFICATIONS	JENX MONKEY	JENX MULTISTANDER		
		SIZE 1	SIZE 1 (ABDUCTION)	SIZE 2
USAGE	Prone	Supine/Prone		
APPROX AGE	9mths - 4yrs	9mths - 6yrs	9mths - 6yrs	3yrs - 13yrs
MAX WEIGHT (KG)	25	35	35	60
MAX HEIGHT OF HEAD SUPPORT (CM)	N/A	116	116	155
FOOTPLATE TO TOP OF CHEST SUPPORT (CM)	51 - 75	49 - 85	50 - 89	75 - 120
CHEST SUPPORT WIDTH (CM)	18.5 - 28.5	14 - 27.5	14 - 27.5	20 - 32
HIP SUPPORT WIDTH (CM)	18.5 - 28.5	14 - 27.5	14 - 27.5	20 - 32
TILT RANGE (90° AS UPRIGHT)	20 - 90	10 - 90	10 - 90	0 - 85 (Electric) 10 - 85 (Gas)
TILT OPERATION	Gas	Gas		Gas or Electric
POSTURAL SUPPORT LEVEL	Mild/Mod	Mild-Complex		
FRAME FOOTPRINT (CM)	58 x 88.5	61.5 x 76	61.5 x 76	67.5 x 107
ABDUCTION	✗	✗	30° each leg	✗
KNEE FLEXION CONTRACTURE ACCOMMODATION	✗	Supine: ✓ Prone: ✗		



JENX STANDZ		JENX SUPINE		
1	2	SIZE 1	SIZE 2	SIZE 3
Supine/Prone		Supine		
1 – 9yrs	5 – 14yrs	9mths – 4yrs	3 – 11yrs	10 – Adult
45	70	25	50	100
138	160	106	146	190
58 – 100	82 – 116	The chest supports can be fitted at any available slot on the supine stander.		
17.5 – 30.5	22 – 36	13 – 31	13 – 31	22 – 44
17.5 – 30.5	25 – 37	13 – 31	13 – 31	22 – 44
5 – 90	0 – 90	10 – 90	10 – 90	5 – 90
Gas		Gas	Electric	
Mild-Complex		Mild-Complex		
64.5 x 89	76 x 107	57.5 x 66	65 x 99	75 x 107
30° each leg		✘		
Supine: ✓ Prone: ✘		✓		

Medifab is as diligent as possible in compiling this information. Medifab does not guarantee the correctness and completeness of the information provided. Equally, Medifab does not guarantee that this information is up to date. For questions concerning our products, their specifications and their utilisation please refer to the instruction manual and/or a product consultant of Medifab. Product specifications are subject to change without notice.

Jenx Monkey Stander

Specifically designed for younger children, the Jenx Monkey is a gentle and fun introduction to standing, providing prone to upright positioning.

Simple and highly adjustable prone/upright standing frame

De-rotational thoracic & pelvic straps with lateral trunk support pads that fasten in the centre and adjust independently from either side, enabling a mid-line position to be achieved and maintained

Polyurethane support surfaces **with antimicrobial agent**



Integral angle-adjustable tray with both bowl and smooth tray infill for a wide variety of different activities

Quick, simple & easy to use.
Comes standard with thumb screw adjustment of growth and postural supports, no tools required!



Gentle, bright & friendly

For parents, a new diagnosis for their young child can be a difficult time, especially when introduced to the world of postural care equipment and the associated vocabulary. The Monkey has been carefully designed to offer the best in early intervention support in a friendly way.



Flexible growth: chest and hip boards can be independently adjusted to support the child as they grow.



Fully upholstered chest, hip and leg boards help make standing more comfortable, to increase standing tolerance.



Angle can be adjusted with the child in the frame and set to the correct angle with infinite adjustment.

ACCESSORIES

Tray Grab Bar

When 1 hand needs to fix to increase functionality
5050-7201-000



Activity Frame

Encourages head control & hand/eye coordination
3615-7475-000



Sandals

Size 1: 5356-6081-000

Size 2 larger users

or with splints:

5356-6082-000



Sandal Raising Blocks

Size 1: 5356-6091-000

Size 2: 5356-6092-000



CASE STUDY: CHILD A

Condition: Hydrocephalus, prematurity resulting in prolonged hospital stay from birth.

Background: Child A was born prematurely with complex needs resulting in a prolonged 18 month stay in hospital. Once home Child A was on home O², PEG fed and presenting developmental delay. He has moderate head control, some trunk activity, but no independent sitting balance.

General and Emotional benefits (from trialling the Jenx Monkey): Child A is able to practice weight bearing and ensure better hip development and bone density. Plus the change of position gives Child A greater access to the world and interaction on that level. As Child A is very small even though nearly 2 years old, sandal raising blocks were needed to ensure the appropriate level of support and a good stand are achieved. The stander has also meant reduced physical support required to be provided by Mum, allowing her to play with Child A on better level, making both mum and Child A much happier.

Code	Age	Max User Weight	Angle Range	Base Size	Chest Height (Foot Support-Chest pad top)	Chest Pad Width	Hip Pad Width	Tray Size
5050-0001-000	9 mths-4 yrs	25 kg	20°-90°	88 x 57.5 cm	51-75 cm	66 x 50 x 60 cm	15-23.5 cm	36 d x 53 w cm

Jenx Multistander

Versatile standing frame, suitable for children from around 9 months right up to 13 years across 2 sizes which provides highly supportive standing. Ideal for growing children in multi-use environments.

Supine, Prone & Upright Standing Frame

De-rotational thoracic & pelvic straps fasten in the centre and adjust independently from either side, enabling a mid-line position to be achieved and maintained. Pads easily remove for side transfers in Supine



Independently adjustable thoracic and pelvic boards cater for the child's individual proportions while giving scope to avoid pressure on delicate areas such as feeding buttons

Deliberately open design ensures you can always see precisely how the user is positioned each and every time

PU boards and support pads are flexible, easy clean and hygienic



Always supportive!

The Multistander is multi-positional meaning it has the flexibility to grow and change with the child easily, supporting them as their skills develop. Prone or Supine configurations mean the correct level of support is always achievable.



Huge growth range. Size 1 shown at smallest height; Size 2 at largest height. (Size 2 provides option for power or manual adjustment).



Angle can be adjusted with the child in the frame and is easily set using the angle gauge.



Set to exactly the right angle with continuous adjustment. Horizontal position assists transfers.

ACCESSORIES



Choose from Lime -054 or Blue -066 colour ways in most accessories

Multigrip Head Support
1 Link: 5356-4601-000
2 Link: 5356-4602-000
3 Link: 5356-4603-000



Moulded Head Support
5230-4101-XXX
Oval Head Support
5356-4611-XXX

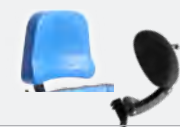

Slim Thoracic Lateral Trunk Supports
5356-3241-XXX

Hi-Rise Thoracic Lateral Trunk Supports
5230-3251-XXX



Multi-Use Tray
Size 1: 5230-7111-000
Size 2: 5230-7112-000
Elbow Blocks: 5356-7351



Multigrip Body Support Size 2:
5230-2721-XXX



Hip Supports
5356-3221-XXX



Sternal Prompt (Prone)
5230-2910-000
Needs cover 5230-8801



Knee Supports
Size 1: 5356-1751-XXX
Size 2: 5356-1752-XXX



Waistcoat Anterior Chest Support
Size 2: 5230-6712-000
Size 3: 5230-6713-000
Size 4: 5230-6714-000



Sandals
Size 1: 5356-6081-000
Size 2: 5356-6082-000
Size 3: 5356-6083-000



Size	Code	Age	Max User Height	Angle Range	Frame Width	Chest Pad Width	Hip Pad Width	Chest Pad Height	Height of Stander	Foot Support
1	5230-0001	9 mths-6 yrs	116 cm	10° - 90°	50-90 cm	9 cm	66 x 50 x 60 cm	Prone 49-86 cm Supine 57-86 cm	67-94 cm	-15°
2	5230-0002	3-13yrs	175 cm	0° - 80°	67-113 cm	10 cm	86 x 80 x 74 cm	Prone 70-117 cm Supine 77-117 cm	83-128 cm	+15°

Jenx Multistander with Abduction

The simple abduction accessory for the Multistander size 1 offers children the opportunity to stand in abduction.

Abduction standing for children as young as 9 months

0-30° hip abduction can be achieved in each leg in 5° incremental stages



Abducted standing close to the floor, facilitating play and interaction with peers at eye level

Simple, tool free adjustment using a strong locking mechanism to keep the hip position secure

Offers smaller children (as young as 9 months) the opportunity to continue standing at peer height in either a neutral or abducted hip position

ACCESSORIES

All Jenx Multistander accessories seen on the previous page, are compatible with the Jenx Multistander Abduction accessory.



Retrofit to your Multistander

The Multistander Abduction accessory is available for purchase as a standalone accessory to retrofit to your existing Multistander Size 1.



Code	Angle Range	Age Range	Max User Height	Frame Width	Frame Length	Chest & Hip Pad Width	Knee Block Width	Height of Stander	Leg Abduction	Max User Weight	Foot Support Angle Dorsiflexion	Foot Support Angle Plantarflexion
5230-5000-000	0-90°	9 mths - 6 yrs	116cm	56.5cm	71cm	14-27.5cm	12-40cm	61-94cm	30°	35kg	15°	15°

This includes the Abduction Accessory only without the Multistander frame.

Jenx Standz Size 1

Standz easily accommodates a range of abducted hip positioning for children between the ages of 1-9.

Supine/Prone/Upright/Abduction Standing Frame



Built in angle gauges for frame angle and individual leg abduction

Tool free adjustments - cleverly designed wing knobs offer a comfortable grip to enable effective clamping with minimal effort

Standz covers have been designed to wipe clean, they also contain an antimicrobial agent to aid infection control

Adjustable supports to accommodate knee flexion contractures and leg length discrepancies



Standard configuration

- Base with castors
- Hydraulic assisted tilt
- Pelvic and trunk support pads with strap
- Abducting legs
- Foot positioning plates
- Tray mount

The Standz is able to be used in the Prone or Supine configuration, depending on your child's needs



ACCESSORIES

Flat Pad Head Support
5240-4110-044



Multigrip Head Support
1 Link 5356-4601-000
2 Link 5356-4602-000
3 Link 5356-4603-000



Flat Shoulder Support
5240-2750-044



Multigrip Body Support
5240-2721-044



Pelvic Support Board
5240-1901-044



Back Pad
5240-2402-044



Standard Knee Support
5240-1750-044



Multi-Axis Knee Support
5240-1770-044



Sandals

Size 1 5356-6081-000
Size 2 5356-6082-000



Tray

Always recommended for Prone configuration
5240-7112-044

Tray Holder

5240-7112-044



Code	Angle Range	Age Range	Max User Height	Frame Width	Frame Length	Chest & Hip Pad Width	Knee Block Width	Height of Stander	Leg Abduction	Max User Weight	Foot Support Angle DorsiFlexion	Foot Support Angle Plantarflexion
5240-0005-044	0-90°	1-9 yrs	138cm	63.5cm	90cm	18-30cm	12cm	108cm	30°	45kg	10°	-25°

Jenx Standz Size 2

Standz 2 offers Prone or Supine standing and easily accommodates either abducted or neutral leg positioning for children between the ages of 5-14.

Supine/Prone/Upright/Abduction Standing Frame

Abduction settings are adjusted through a cleverly designed plunger system, locking the setting at the desired level and preventing movement

Tool free adjustments - cleverly designed wing knobs offer a comfortable grip to enable effective clamping with minimal effort

Covers have been designed to wipe clean, they also contain an antimicrobial agent to aid infection control

Can be configured to be tool adjustable only, limiting unwanted movement of supports.

Adjustable supports to accommodate knee flexion contractures and leg length discrepancies



Base Frame Features

- 4 lockable swivel castors
- Tilt mechanism with dedicated release lever on handle with safety lock
- 0°-30° independent abduction movement of leg posts in 5 degree increments with easy to use locking plunger
- Individual footplates with angle adjustment for plantar and dorsiflexion
- Tilt range of 5°-90° with easy to read angle gauge
- Pelvic and trunk support boards and cover pads

The Standz 2 is able to be used in the Prone or Supine configuration, depending on your child's needs.

Enhanced Upper Limb Positioning

Supportive upper limb accessories ensure that the user is in the best position for function whilst standing, stabilising the shoulder and promoting midline function.



Code	Average Age	Weight Capacity	Hip Width	Hip Height	Chest Width	Chest Height	Max Height	Tilt Range (90° = Upright)	Frame Width	Frame Length	Height off surface when horizontal	Abduction Range
5242-0005-054	5-14yrs	70kg	25-37cm	50-95cm	22-36cm	82-116cm	160cm	0-90°	76cm	107cm	90cm	30°

Accessories

Standard Knee Support
5242-1750-054



Standard Knee Straps
Size 1 5242-1766-054
Size 2 5242-1767-054



Rotation Control Knee Straps
Size 1 5242-1786-054
Size 2 5242-1787-054



Flat Shoulder Support
5242-2750-054

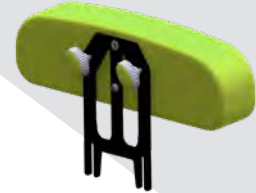

Shoulder Support
Size 1 5242-2751-054
Size 2 5242-2752-054



Flip-Away Lateral Support with Strap
5242-3371-054



Flexi Flip Away Lateral Support with Strap
5242-3372-054



Ankle Snugs
Size 1 5356-6121-000
Size 2 5356-6122-000



Sandals
Size 1 5356-6081-000
Size 2 5356-6082-000
Size 3 5356-6083-000

Multi-Axis Knee Support
Size 1 5242-1770-054
Size 2 5242-1771-054



Knee Block
Size 1 5356-1751-000
Size 2 5242-1767-054

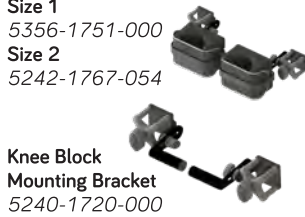

Knee Block Mounting Bracket
5240-1720-000

Oval Head Support
5356-4611-054



Flat Head Support
5240-4110-054



Multigrip™ Head Support Link
1 Link 5356-4601-000
2 Link 5356-4602-000
3 Link 5356-4603-000



Pelvic Support Board
5242-1903-054



Pelvic Support Board Back Pad
5242-1902-054



Waistcoat
Size 2 5242-6252-000
Size 3 5242-6253-000



Anti Tamper Conversion Kit
5240-0170-000



Multi-Position Tray
5242-7110-054

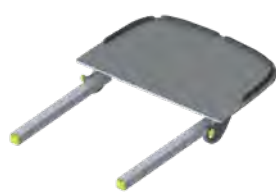

Full Tray Padding
5242-7115-000



Tray Mounting Bracket
5242-7009-054



Multi-Position Tray with Bowl
5242-7113-054

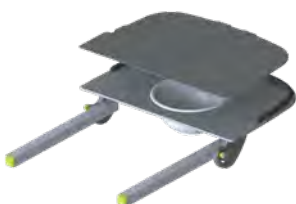

Tray Extension Wings
5242-7355-000



Tray Padded Wings
5242-7116-000



Tray Elbow Blocks
5356-7351-000



Standz 2 can be configured to be tool adjustable only, limiting unwanted movement of supports.

Jenx Supine Stander

Highly supportive supine standing offering easy transfers and support of complex postures from 9 months to adults up to 100kg.

Robust Support and Safety

Size 3 has exclusive **numbered boards** so that set-ups can easily be recorded and recreated in a multi-user environment

De-rotational thoracic & pelvic straps fasten in the centre and adjust independently from either side, enabling a mid-line position to be achieved and maintained

Split angle adjustable foot support for Size 3 and Single footboard for Size 1/2



PU boards and support pads are flexible, easy to clean and hygienic

De-rotational and flexion control accessories available to customise knee support for each individual



Supporting development

The adjustable supports of the Jenx Supine Stander mean that support can be tailored to each individual based on their level of function. To support development, freedom of movement at different joints can be gradually introduced to assist with training of balance and motor control.



Easy set up using the frame's angle gauge. Angle can be adjusted with user in the frame.



Infinite and precise angle adjustment from upright 90° through to horizontal.



Smooth and easy transfers with ability to remove support pads fully. Less carer strain!

ACCESSORIES



Choose from Lime -054 or Blue -066 colour ways

Multigrip Headrest

1 Link: 5350-4601-000
2 Link: 5350-4602-000
3 Link: 5350-4603-000

Head Pad Cushion

Size 3: 5353-4602-066
1/2 & wings: 5350-4650-XXX
3 & wings: 5350-4103-XXX



Support Pads & Straps

Small: 5356-3222-XXX
Medium: 5356-3241-XXX
Large: 5353-3223-XXX
X-Large: 5353-3224-XXX

Knee Blocks & Straps

Small: 5350-1761-XXX
Medium: 5350-1762-XXX
XL 1: 5353-1765-XXX
XL 2: 5353-1766-XXX
XL 3: 5353-1767-XXX



Flexion Control Knee Support

Medium: 5350-1772-XXX
XL 1: 5353-1775-XXX
XL 2: 5353-1776-XXX
XL 3: 5353-1777-XXX

Adjustable Tray

Size 1/2: 5350-7111-000
Size 3: 5353-7113-000
Elbow blocks: 5356-7351
Tray Extension Wings: 5353-7170-000



Medial Knee Support (for Size 3)

5353-1603-066
Arched Foam Pad Support behind flexed knees 5353-1775-000
Spacer 5353-2730-000

Sandals

Size 1: 5356-6081-000
Size 2: 5356-6082-000
Size 3: 5356-6083-000
Size 4: 5356-6084-000



Size	Code	Age	Max User Weight	Max User Height	Base Size	Tilt	Chest Width	Hip Width	Knee Pad Width	Board Height to Foot Support
1	5350-0001-XXX	9 mths-4 yrs	25 kg	105.5 cm	57.5x66 cm	0-80°	13-31 cm	13-31 cm	13-31 cm	50-1-07 cm
2	5350-0002-XXX	3-11 yrs	50 kg	145.5 cm	65x99.5 cm	0-80°	13-31 cm	13-31 cm	13-31 cm	90-147 cm
3	5353-0003-066	10-18yrs	100 kg	190 cm	76x99.5 cm	0-80°	22-44 cm	22-44 cm	22-44 cm	154-164 cm



Providing creative
solutions for
everyday tasks



Bathroom



Showering and bathing are both essential activities however they can be the most challenging. Find the correct bathroom aids that make these tasks easier and simpler, and provide a practical yet supportive solution.

Sharky Bathroom Chair

74

Sharky Bathroom Chair

Sharky has been designed for multifunctional applications and ease of handling.

Multifunctional commode for bath and shower use

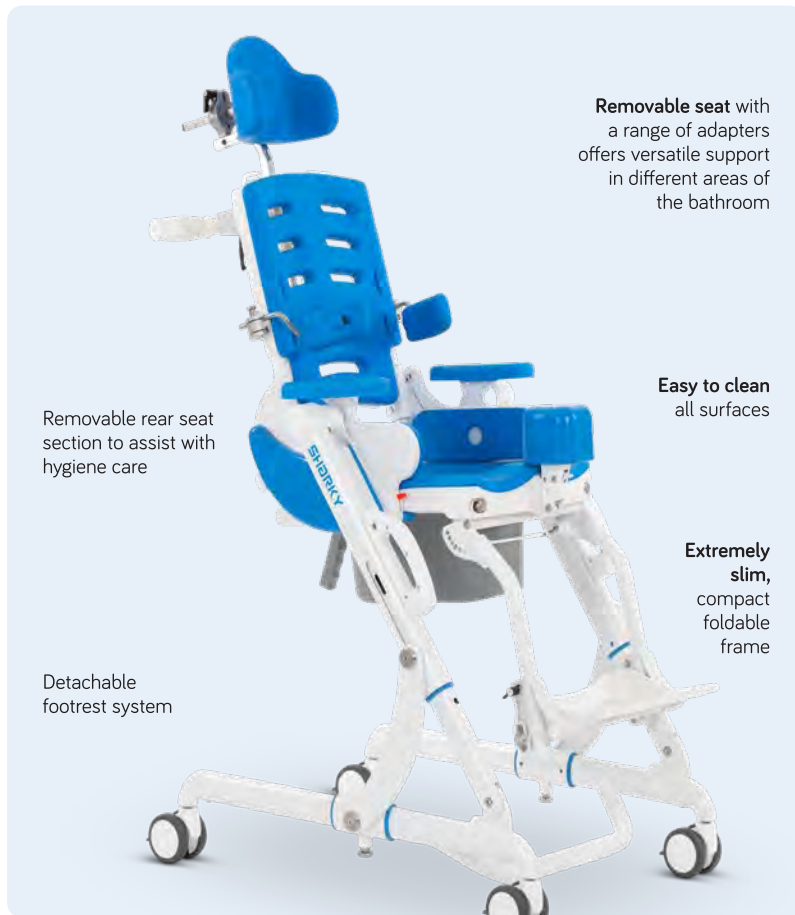

Removable seat with a range of adapters offers versatile support in different areas of the bathroom

Removable rear seat section to assist with hygiene care

Easy to clean all surfaces

Extremely slim, compact foldable frame

Detachable footrest system

BACK SUPPORT RECLINE

Simple to use system for easy and secure handling.



45° TILT

The special construction of the tilt mechanism allows to 45° tilt of seat to ensure comfort and high safety especially when showering.



HEIGHT ADJUSTMENT

Smooth movement with comfortable handles make adjustments easy and controlled.



COMPACT FOLDING

Fold down to compact height of just 28cm, even with seat attached, makes transport and storage easy.



REMOVABLE PADDING

Easy care removable padding for cleaning the Sharky.



Size	Base Code	Seat Width	Seat Depth	Back Support Height	Toilet Clearance	Seat Angle	Back Support Angle	Knee Angle	Foot Support Angle	Armrest Height	Wheel Diameter	Weight Limit
1	6081-0015-000	24, 27, 30cm	27-36cm	42cm	52cm	-10° to 45°	72-120°	78-138°	80-100°	14,5 - 20,5cm	75, 100cm	60kg
2	Launching Soon	29, 32, 35cm	27-40cm	42cm	52cm	-10° to 45°	72-120°	78-138°	80-100°	14,5 - 20,5cm		

Accessories

Removable Footrest System
6085-1810-000



Push Handles
6085-8600-000



Lateral Trunk Supports
1: 6085-3310-000
2: 6085-3320-000



Headrest
6085-4750-000



Neoprene Shoulder Anterior Chest Support
1: 6085-6610-000
2: 6085-6620-000



Hip Belt with Neoprene Pad Sizes
1: 6085-1910-000
2: 2880-1920-000



Removable & Height Adjustable armrest
6085-5500-000



Abduction Block
1: 6085-1500-00



Depth Adjustable, removable tray table
6085-7100-000



Neoprene Calf Strap
6085-6160-000



Neoprene Ankle Huggers
1: 6085-6101-000
2: 6085-6102-000



Removable Commode Pan with retainer
6085-8210-000



Removable Splash Guard
6085-7675-000



Seat Infill pad
6085-0401-000



Bath subframe with seat angle adjustment
6085-0500-000



Toilet Adapter
6085-0600-000



Seat width reducing hip supports
1: 6085-1110-000
2: 6085-1120-000
3: 6085-1130-000





Lying and Positioning



A 24-hour postural management program is essential to ensuring a user's posture is maintained at its optimum level.

Because everyone is different and has different needs for positioning, Medifab's lying and positioning range includes basic pillows to highly customised sleeping systems.

Offering a large array of components that can be customised to suit the users needs and body shape.

Poz-in-Form	78
Care Wave	82
Simple Stuff Works	88
Dreama	94

CARE CONCEPT
POZ' IN' FORM®
 PHARMAQUEST INDUSTRIES

Poz'In'Form® cushions are designed to perform various support and comfort functions to support users in lying and at night time. The microfibers prevent from creep effects that are regularly observed in classical positioning and from early deterioration of the support. The various forms, sizes and models of Poz'In'Form® allow for a wide range of positioning possibilities.

- Poz'In'Form® elements and modules are entirely removable and washable. They are delivered with a Pharmatex or Lenzing FR® cover.
- The Pharmatex bi-elastic cover is made of polyurethane and is recommended for use in healthcare facilities. Pharmatex is soft to the touch and very comfortable next to the skin, while still easy to clean.
- The Lenzing FR® cover is made of viscose, coated with a waterproof polyurethane film. Lenzing FR® is a major innovation in positioning of the long-term bedridden, preventing maceration. Hygroscopic properties of viscose allow moisture absorption which is particularly important for people with thermoregulation issues. Moreover elasticity and flexibility of Lenzing FR® are particularly suitable for problems regularly observed in classical positioning.
- Lenzing spare covers can be purchased to cover Pharmatex pillows for a more absorbent feel.



Poz'In'Form Delta

- This cushion is highly versatile, able to support users with a range of positioning needs. Under the knees, it provides support to the joint to maintain some flexion. Used in this way, the Delta also prevents users from sliding down in their beds which reduces friction and shear forces on the sacrum.
- It can be used in a semi-fowler position and helps to maintain positioning while relieving pressure in sensitive areas (sacrum, ischial tuberosities, heels) and shifting it to low-risk zones (calves, thighs and back).

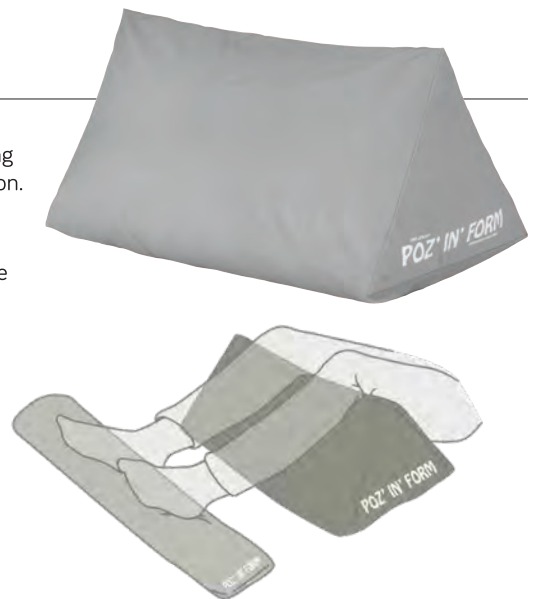

	With Pharmatex Cover	With Lenzing FR® Cover
Code	7009-0551-269	7009-0551-279
Length	56 cm	56 cm
Height	28 cm	28 cm
Depth	32 cm	32 cm

Poz'In'Form Universal

- Thanks to the three sizes, the universal cushion can be used in many different ways. The larger size can be useful for supporting knee flexion or moderate hip abduction when the user is in supine.
- The small cushions provide additional support to the user where needed, thus reducing the risk of abnormal postures or areas of high pressure.



	With Pharmatex Cover
Code	7009-1252-269
Length	55 cm
Depth	40 cm

	With Lenzing FR® Cover
Code	7009-1252-279
Length	55 cm
Depth	40 cm

Poz'In'Form Cylindrical

- Placed between the legs, the cylinder supports the upper hip and knee joints to be better aligned, reducing unwanted hip adduction and other unwanted changes to posture.
- In supine the cylinder can be applied behind the calves to alleviate pressure caused by contact between the users heels and the mattress surface.

	With Pharmatex Cover	With Lenzing FR® Cover
Code	7009-1501-269	7009-1501-279
Length	75 cm	75 cm
Diameter	18 cm	18 cm



Poz'In'Form Half-Moon

- Used in supine to provide support to the head, neck and upper limbs, including the shoulders.

	With Pharmatex Cover	With Lenzing FR® Cover
Code	7009-1851-269	7009-1851-279
Length	200 cm	200 cm
Width	30 cm	30 cm



Poz'In'Form Hand Wedge

- Cushion for the hands, wrists and forearms to provide greater surface area contact and distribute pressure more evenly.
- Can be particularly useful after certain surgical procedures where improved upper limb positioning is needed.

	With Lenzing FR® Cover
Code	7009-5411-279
Length	39 cm
Height	9 cm
Width	22 cm



Poz'In'Form Semi-Lateral Decubitus

- Used to provide body length support in semi side lying positions, from the top of the shoulders to the feet and ankles.

	With Pharmatex Cover	With Lenzing FR [®] Cover
Code	7009-3001-269	7009-3001-279
Length	185 cm	185 cm
Width	35 cm	35 cm



Poz'In'Form Ring & Half Ring

- In combination with the cylindrical cushion the half ring can provide medial thigh and knee support, preventing hip adduction and supporting a neutral position.
- Used for positioning the neck and head, providing a comprehensively supported position when used in combination with other cushions.

	With Pharmatex Cover	With Lenzing FR [®] Cover
Half Ring Code	7009-4051-269	7009-4051-279
Ring Code	7009-4081-269	7009-4081-279
Length	105 cm	135 cm
Width	22 cm	20 cm



Poz'In'Form Occiput

- Used to provide positioning and pressure relief to the occipital area in supine. Combination layers of microfibre and memory foam provide optimised pressure distribution.

	With Pharmatex Cover	With Lenzing FR [®] Cover
Code	7009-4751-269	7009-4751-279
Length	50 cm	50 cm
Height	9 cm	9 cm
Width	40 cm	40 cm



Poz'In'Form Heel Cushion

- Used at the bottom of the bed and fixed with an adjustable strap.
- Provide support behind the calves to raise the feet away from the mattress surface, thus reducing contact and associated areas of high pressure particularly at the heels.

	With Lenzing FR® Cover
Code	7009-5201-279
Length	85 cm
Diameter	25 cm



Poz'In'Form Heel Wedge

- Alternative cushion shape for supporting the calve and relieving pressure from the heel area.
- The large surface area of the cushion provides additional support for larger calve sizes or where more contact is needed to support the user.

	With Lenzing FR® Cover
Code	7009-5401-279
Length	48 cm
Height	12 cm
Width	30 cm



CareWave Cylindrical



- Can be used between legs, under heels and ankles in order to reduce pressure.
- Prevents the user from falling forward from a decubitus position.
- Provides sufficient support to achieve a corrected position for many users.
- Use for corrected side lying positioning for sufficient angles to keep the airway open and to ensure a neutral position in the involved joints.

	Small	Large
Code	7007-1502-045	7007-1501-066
Length	45 cm	70 cm
Diameter	14 cm	17 cm
Cover Code	7007-1502-270	7007-1501-270



CareWave Abduction



- Use when the patient is lying down, placed in crotch area.
- Can also be placed under the arm.

	Small	Large
Code	7007-1552-045	7007-1551-066
Width	12 cm	15 cm
Depth	23 cm	30 cm
Height	15 cm	20 cm
Cover Code	7007-1552-270	7007-1551-270



CareWave Semi-Fowler



- Gives support and holds the user comfortably in a semi-fowler position.
- Place the cushion under the legs, the abduction module forward between the knees.

	Small	Large
Code	7007-1852-045	7007-1851-066
Width	50 cm	70 cm
Depth	35 cm	50 cm
Height	12 cm	14 cm
Cover Code	7007-1852-270	7007-1851-270



CareWave Decubitus

- Supports shoulders, back, hips and knees of the user in a decubitus position. Reduces rubbing.
- Provides excellent trunk stability while the hip and knee angle can be varied.
- Lower part of the "S" can be drawn up between the knees so that the right median and good body symmetry can be achieved.
- Can also be shaped into a U-shaped cushion by adjusting the fill and rotating one end to thus provide a neutral position for the knee and hip joints, while the pad is pushed under the seat to fix the pelvis.
- The ends also provide support for the elbows.

	Small	Large	XX Large
Code	7007-3002-045	7007-3001-066	7007-3004-066
Width	25 cm	30 cm	36 cm
Length	140 cm	180 cm	200 cm
Cover Code	7007-3002-270	7007-3001-270	

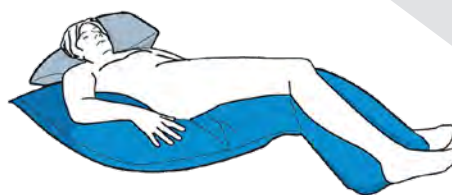

CareWave Body Bolster

- New addition to the CareWave range, which allows full support of the body from head to feet.
- An integrated pillow facilitates installation and user comfort and successfully maintains user position.
- When used in lateral position, the Body Bolster protects against pressures and avoids friction and pressure points on arms, knees and calves.

	Small	Large
Code	7007-3502-045	7007-3501-066
Length	135 cm	210 cm
Width	20 cm	35 cm
Cover Code	7007-3502-270	7007-3501-270



CareWave Back Cushion

- Maintains the back in a semi-sitting position when user is sitting in bed or in a lateral decubitus position. Helps reduce pressure on ischium and heels.
- Can also be used in a sitting position in a chair.

	Small	Large
Code	7007-2452-045	7007-2451-066
Length	200 cm	200 cm
Width	40 cm	60 cm
Cover Code	7007-2452-270	7007-2451-270

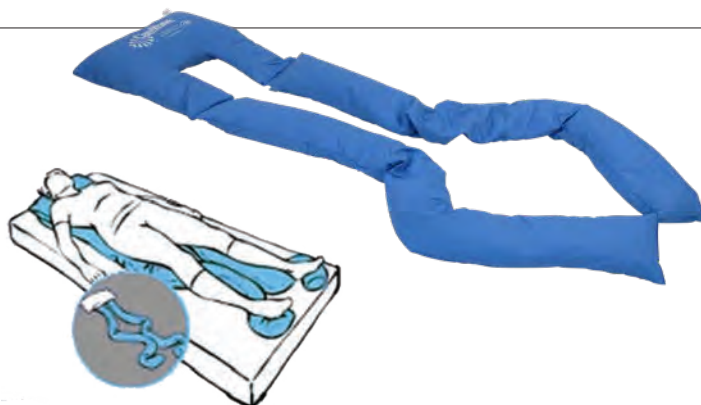

CareWave Half-Moon

- It gives support and holds the patient comfortably in a lying or sitting position, and can be used to stabilize the upper body. The filling can be moved within the cushion so you can arrange it to adjust the head and arm height.
- If one wishes to counteract unwanted lateral movement of the body, the ends of the Half-Moon can be pushed under the hip area. Body weight will stabilize the pelvis and prevent unwanted movement. The idea is to eliminate movement that will take the body out of the desired symmetrical position.

	Small	Large
Code	7007-4052-045	7007-4051-066
Length	140 cm	180 cm
Width	25 cm	30 cm
Cover Code	7007-4052-270	7007-4051-270



CareWave Ring Cushion

- Comfortably supports the user's head. If support is required especially on one side, the special filling can be shaken to one side of the cushion and positioned slightly skewed to one side if needed.
- Can be positioned with the opening towards the patient's visual direction which allows for a stable position for the head and neck, backwards and sideways.
- If the patient has the ability to make a lot of head movement the pillow can move out of place so the patient must be able to move the pillow or get help with this.



	Small	Large
Code	7007-4082-045	7007-4081-066
Width	35 cm	40 cm
Cover Code	7007-4082-270	7007-4081-270

CareWave Universal

- Use to avoid rubbing between knees, calves or heels.
- Placed under the feet, it helps to reduce pressure on heels.
- Can also be used simply as a pillow.

	Small	Large
Code	7007-1252-045	7007-1251-066
Length	45 cm	60 cm
Width	30 cm	40 cm
Cover Code	7007-1252-046	7007-1251-067



Fitleg Evo

- Fitleg Evo has abduction module to limit friction around knee articulations and prevent leg-crossing in case of spasticity.
- Positioning device for proper orthopaedic alignment of lower limbs which prevents front sliding, friction and shear. Anatomic shape provides maximum comfort and stable positioning.
- Prevention of knee hyper-extension due to the anatomic shape.
- Viscoelastic foam combined with HR foam base to provide maximum comfort.
- Reduces pressure on heels area with support on calves and thigh.



	Fitleg Evo
Code	7007-1811-066
Length	58 cm
Width	55 cm
Height	12 cm

Ear Protection Cushion

- Comfortably supports the patient's head and relieves contact on the ear area in order to prevent bedsores.
- Comes standard with two cotton covers.



	One Size
Code	7007-4751-066
Length	30 cm
Width	30 cm



Hemi-Care Cushion

- Supports and holds the upper limbs in a stable position. Both parts of the Hemi Arm are fixed together with Velcro strips.
- Maintains the arm in a position which cannot slide and reduces pressure on elbow area so that there is no sensation of tear strength in the shoulder. For users with kyphosis, the Hemi-Care cushion helps maintain the back straight.



	Small	Large
Code	7007-5522-045	7007-5521-066
Length	45 cm	48 cm long
Width	30 cm	35 cm



CareWave Heel Cushion

- Fixes to the mattress at the heel area with an adjustable strap.
- Supports ankles and relieves pressure on the heel zone.

	One Size
Code	7007-5201-066
Length	90 cm
Width	18 cm

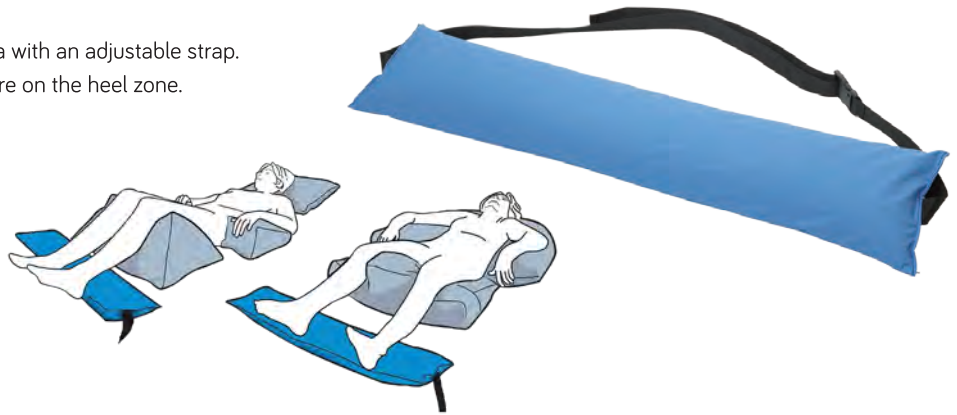

CareWave Heel Bootie

- Designed to protect and prevent the feet/heels from injury and bedsores and to provide comfort whatever the patient's position.

	Small	Large
Code	7007-5302-045	7007-5301-067
Length of foot surface	25 cm	30 cm



CareWave Delta

- Create lateral stability either alone, with one on each side, or an extra pillow to create a neutral position in the knee & hip joints.
- Supports and prevents the patient from falling forward from a decubitus position.
- Can be used in a semi fowler position, by placing under the legs.

	Small	Large	XX Large
Code	7007-0552-045	7007-0551-066	7007-0554-066
Width	40 cm	55 cm	180 cm
Depth	20 cm	30 cm	30 cm
Height	20 cm	30 cm	30cm
Cover Code	7007-0552-270	7007-0551-270	7007-0554-270



CareWave Details

- Body positioning system which offers lying and seating support to infants and adults.
- Various cushion shapes are available depending on the user's need for positioning.
- Unique micro-particle padding provides flexibility and a moulding effect, essential to support asymmetric postures, fill body gaps and for comfort around the user's body and limbs. Available in two sizes.
- Outer cover of CareWave cushions: Waterproof and breathable Polyamid bi-elastic fabric (47%) coated with polyurethane (53%) Coating with antibacterial treatment.
- Filling: 100% Polystyrene micro-particles.
- Fire standard: Passes the requirements of EN 597 - 1&2 and EN ISO 12952 - 1 to 4.



COLOUR IDENTIFICATION

GREEN CAREWAVE = Small sizing
BLUE CAREWAVE = Large sizing



Cushion Covers

- Cushion covers can be added to most sleep system items. Medifab suggest that at least one cover is purchased with each cushion.
- Benefits include:
- Quick and easy to launder.
 - Breathability, allows skin to release moisture without undue discomfort or pressure marking
 - Warm to touch, adds comfort.
 - Absorbent - wicks away perspiration, saliva etc.



Cleaning Instructions

- Cushion Maintenance:
Wipe with usual detergent.



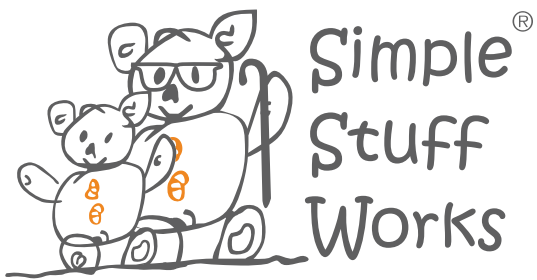

From our family to yours

The Simple Stuff Works way provides high quality education and therapeutic positioning equipment with an aim to eradicate the preventable problems associated with body shape distortion.

Simple Stuff Works advisors and colleagues are all highly experienced, having written some of the leading research into Postural Care and its effects. Medifab educators have been upskilled by these individuals and are ambassadors to promote protection of body shape.



Therapeutic positioning requires a comprehensive understanding from everyone involved if it is to be implemented successfully. Medifab with Simple Stuff Works is equipped to offer a range of training to support families, healthcare professionals and indeed anyone with an interest in therapeutic positioning. Our courses are accredited and license delegates to join a worldwide community of Postural Care Leaders with access to all our training materials and support.

Simple Stuff Works take pride in the fact that their equipment is silent, hygienic and simple to use. Training programs are available in Australia and New Zealand and will allow you to implement this powerful form of therapy as safely and as humanely as possible.



Simple Stuff Works Packages

Packages are available in three sizes with common items

	Infant Package	Child Package	Adult Package
Code	7150-7001-C00	7150-7002-S00	7150-7003-S00
User Age	For infants from 0 to 5 years of age	For children from 5 to 12 years of age	For adults from 12+ years of age
Package Includes	<ul style="list-style-type: none"> • 2x cot bed mesh • 2x cot toppers • 2x cot cotton sheets • 2x small lateral supports • 2x small wedges • Small roll pillow • Small horseshoe pillow • Travel bag 	<ul style="list-style-type: none"> • 2x single bed mesh • 2x single toppers • 2x single cotton sheets • 2x medium lateral supports • 2x medium wide wedges • Standard horseshoe pillow • Size 3 supine stabilizer • Travel bag 	<ul style="list-style-type: none"> • 2x single bed mesh • 2x single toppers • 2x single cotton sheets • 2x medium lateral supports • 2x medium wide wedges • Standard horseshoe pillow • Size 4 supine stabilizer • Travel bag



Simple Stuff Works Stabilising Mesh

- The base of the sleep system starts with a set of two layers of non-slip mesh. Supports are placed between the two layers around the individual to create the ideal position for them.
- One of the most hygienic bases for a positioning system being anti-microbial, complete with SteriTouch running through it, anti-mite, anti-fungal, entirely washable and conforms to Oeko-Tex Standard 100.
- Firmly holds any supports and is completely silent to use, making changes in position throughout the night as gentle and calm as possible.
- Can be used to also hold other pieces of equipment in place as well as holding the individual which means that the overall positioning system is very secure whilst allowing for easy changes in position.

	Cot Bed Size	Single Bed Size
Code	7150-7011-C00	7150-7012-S00
Length	Base layer: 1600mm Top layer: 1600mm	Base layer: 1790mm Top layer: 1810mm
Width	Base layer: 1530mm Top layer: 1080mm	Base layer: 1520mm Top layer: 990mm



Simple Stuff Works Temperate Topper

- Pair of soft mattress toppers which are non-dynamic, neither cooling nor warming the individual so as not to interfere with their unique temperature regulatory system; an essential safety feature for those who find it difficult to control their own temperature.
- Used underneath the sheet on top of the layers of Stabilising Mesh.
- Made with a state-of-the-art material which is machine washable to 90°
- Wicks moisture away from the skin and allows air to circulate around an individual, helping to maintain a dry, temperate environment for them to rest in.
- Single size can also be used on larger beds.

	Cot Bed Size	Single Bed Size
Code	7150-7051-C00	7150-7052-S00
Length	1000mm	1000mm
Width	590mm	1000mm



Simple Stuff Works Fitted Sheets

- Made from a beautiful material which is hard wearing but soft to ensure maximum comfort.
- Extra big and stretchy so that supports can be placed around an individual and the sheet will still conform to their body.
- Double bed sizes available on request.

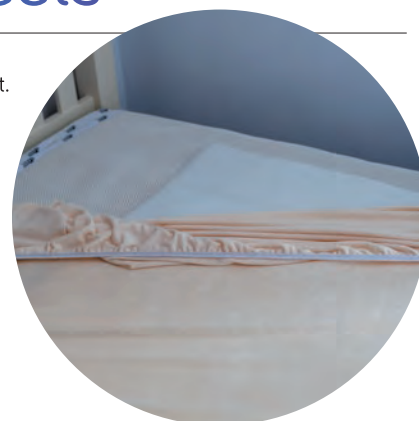

	Cot Bed Size	Single Bed Size
Code	7150-7121-C00	7150-7122-S00
Length	1400mm	1900mm
Width	700mm	900mm

Simple Stuff Works Wedges

- Made with a specialist fibre and covered in a soft yet durable polyester-mix material.
- Fibre is highly breathable and wicks moisture away from the skin allowing the person to remain comfortable whilst reducing the risk of tissue damage.
- Tapered at one end to facilitate use in a variety of positions.
- Also available in option for air mattresses designed to grip directly to the mattress surface. See scripting and ordering guide for more information.



	Small Narrow	Small Wide	Medium Narrow	Medium Wide	Large
Code	7150-7311-000	7150-7312-000	7150-7313-000	7150-7314-000	7150-7316-000
A	150mm	220mm	360mm	310mm	490mm
B	80mm	120mm	90mm	130mm	130mm
C	80mm	100mm	80mm	110mm	110mm
D	80mm	100mm	200mm	200mm	330mm

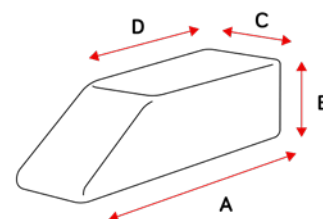

Simple Stuff Works Padded Lateral Supports

- Perfect for providing firmer support for an individual using our therapeutic positioning equipment.
- L-shaped with soft, washable, removable pads which cover them.
- Positioned between the two layers of stabilising mesh which holds them in place securely.
- Can also be used to stabilise other support items such as leg supports or pillows.
- Also available in option for air mattresses designed to grip directly to the mattress surface. See scripting and ordering guide for more information.



	Small	Medium	Large
Code	7150-7201-000	7150-7202-000	7150-7203-000
A	180mm	220mm	280mm
B	120mm	140mm	220mm
C	180mm	220mm	280mm

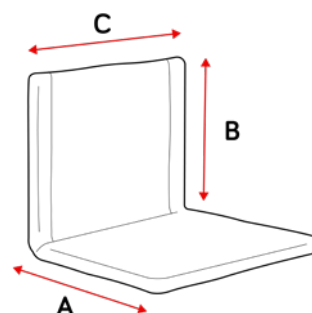

Simple Stuff Works Supine Stabiliser

- Leg support piece which is designed to help an individual to keep a neutral, supine position for long periods of time.
- Worn above the knees, across the thighs, it stabilises the pelvis and the femora.
- Supports the legs to be therapeutically aligned from a habitual, unsupported, or destructive position.
- Can be used with individuals of all ages during immobilisation after surgery, to therapeutically align the legs and avoid contractures.
- Available with either a standard terry towelling outer, or combination of wipeable inner and a terry towelling outer.



	Size 1	Size 2	Size 3	Size 4	Size 5
Standard	7150-7371-000	7150-7372-000	7150-7373-000	7150-7374-000	7150-7375-000
Wipeable inner/ terry outer	7150-7381-000	7150-7382-000	7150-7383-000	7150-7384-000	7150-7385-000
A	350mm	420mm	490mm	580mm	720mm
B	240mm	290mm	300mm	320mm	380mm
C	100mm	130mm	180mm	220mm	220mm
D	130mm	170mm	190mm	210mm	210mm
E	90mm	90mm	100mm	110mm	110mm
F	40mm	70mm	70mm	70mm	70mm

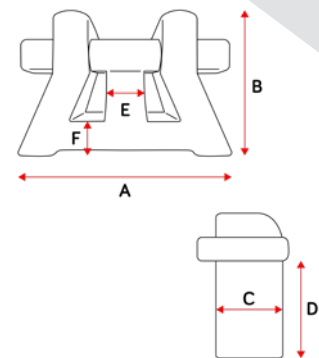

Simple Stuff Works Multi-Plane Stabiliser

Promotes increased internal or external rotation & increased hip & knee flexion (suitable for air & foam mattresses)

- Dynamic leg support piece to support the legs in a therapeutic position.
- It has the ability to either internally or externally rotate the legs depending on what position would be beneficial for the individual, as well providing a suitable level of abduction of the hips to keep them comfortable and in joint.
- Designed to help an individual to keep a neutral, supine position for long periods of time, it is worn above the knees, across the thighs, and it stabilises the pelvis and the femora.

	Size 1-2	Size 3-4
Standard	7150-7471-000	7150-7473-000
Wipeable inner/terry outer	7150-7471-WIP	7150-7473-WIP
A	440mm	600mm
B	240mm	250mm
C	320mm	410mm
D	200mm	200mm
E	100mm	150mm
F	90mm	140mm
G	100mm	140mm
H	70mm	70mm

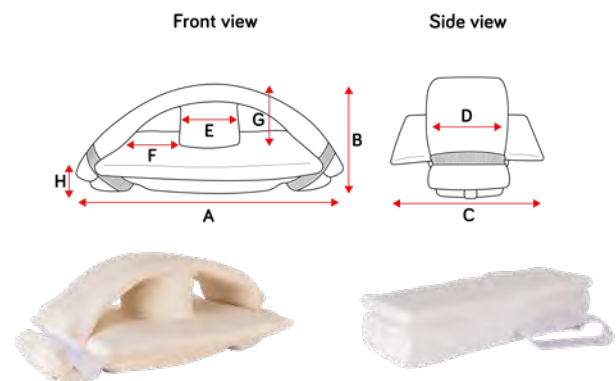

Simple Stuff Works Side Lying Leg Support

- Designed to protect the hips and pelvis when a person is lying on their side.
- The leg channel creates a perfect place for the top leg to lie and the bottom leg wraps gently around the outside.
- When combined with lots of support along the person's back, a supportive side lying position can be achieved.
- Perfect for individuals who need to lie on their side for safety reasons.

	Size 1	Size 2	Size 3
Standard	7150-7971-000	7150-7972-000	7150-7973-000
Wipeable inner/terry outer	7150-7981-000	7150-7982-000	7150-7983-000
A	270mm	400mm	400mm
B	380mm	560mm	610mm
C	280mm	340mm	400mm
D	80mm	100mm	110mm
E	130mm	200mm	150mm
F	80mm	90mm	70mm

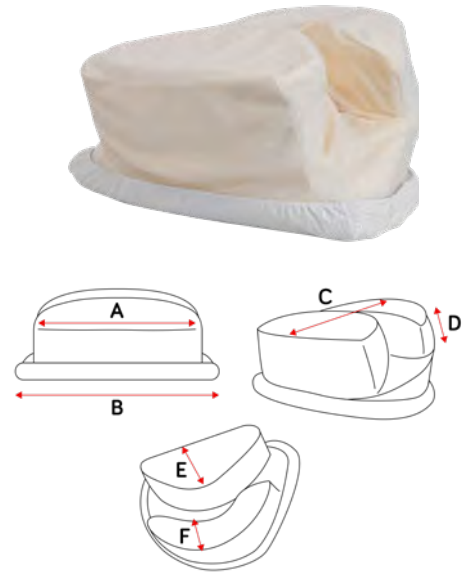

Simple Stuff Works Foot Support

- Designed to hold the feet in a neutral position for long periods of time.
- Made from the same fibre as the Temperate Toppers so they help to keep the feet feeling fresh whilst they are protected from falling forwards or rotating.
- Terry towelling outer makes for a comfortable and soft feel on the feet.
- Easy clip system makes it easy to put on and take off.

	Size 1	Size 2	Size 3
Code	7150-5351-000	7150-5352-000	7150-5353-000
A	210mm (max)	250mm (max)	300mm (max)
B	200mm	220mm	300mm



Simple Stuff Works Neck Support Pillow

- Great option for supporting an individual's neck.
- Made from a soft fibre and covered in a comfortable yet durable polyester-mix material.

	Neck Support Pillow
Code	7150-4050-000
A	350mm
B	300mm

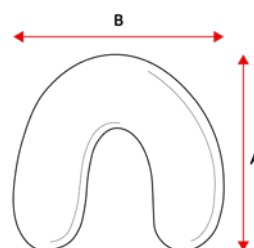

Simple Stuff Works Horseshoe Pillow

- Made from a soft fibre and covered in a comfortable yet durable polyester-mix material.
- Can be used for a variety of different functions and is normally used to support the user's legs.
- Can be used between the two layers of stabilising mesh, or on top of the sheets

	Small	Large
Breathable inner/terry outer	7150-7711-000	7150-7712-000
Wipeable inner/terry outer	7150-7721-000	7150-7722-000
A	460mm	500mm
B	190mm	200mm

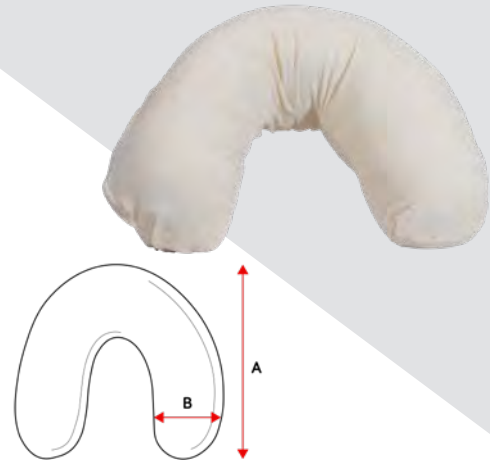

Simple Stuff Works Head Positioning Pillow

- Universal supportive positioning pillow to provide the extra support where required.
- Can be used between the two layers of stabilising mesh, or on top of the sheets.
- Covered by a soft and comfortable, yet durable terry towelling cover.

	Small	Large
Code	7150-7501-000	7150-7502-000
Length	480mm	680mm
Width	350mm	450mm



Dreama Positioning

- Combined pressure reducing mattress and postural support system, suitable for children and adults.
- Supporting at risk children and adults to achieve supported positioning for lying, helping to reduce muscle tone and contribute to better quality of sleep.
- Dreama can be used to help reduce the risk of body shape changes and deformity for those who are at risk due to their condition or diagnosis.
- Designed to be very easy to keep clean and keep hygienic.
- Glide-lock technology means configurations can be changed with minimum disruption to the user. This key feature helps to accommodate and correctly position posture overnight, whilst maintaining a high level of comfort.



- Contour the flexible aluminium base for a custom lying surface. Suits profiling beds, rolls, wedges.

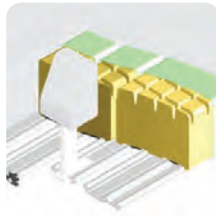

- Quiet with no noise or disturbance when adjusting positions due to Glide-lock supports.

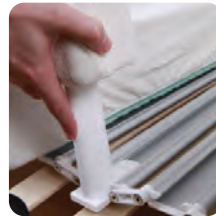

- Quick, simple assembly, and exceptional flexibility with numerous accessories.



Dreama Base & Mattress

- Includes flexible aluminium base, full set of mattress cells, full set of neutral covers, and pair of anchor straps.
- Pressure-reducing 15 cm deep modular mattress removes the need for overlays.
- Individual covers for each cell mean that if soiled, only the covers that need washing can be removed and replaced saving time and energy.
- Spaces between mattress cushions allow airflow, helping to maintain a comfortable temperature. Covers are upholstered in fire-retardant, water resistant, 2-way stretch, antibacterial fabric for infection control.
- Add locking feet (#7120-6100-000) to mark the position where an accessory should be placed. Locking feet keep accessories in place for users with strong movement.

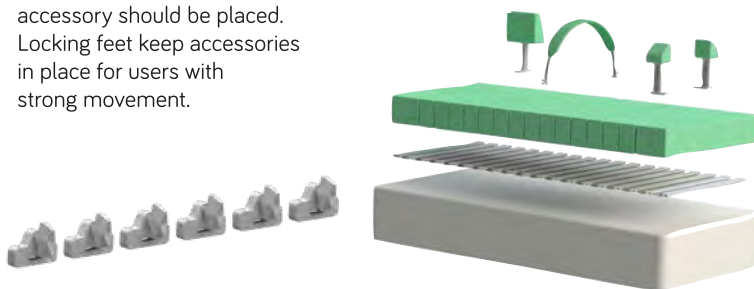

	Single bed
Code	7120-0020-000
Age range	9mths - adult
Overall size	90 x 190cm
Overall height	17cm
Single mattress cushion	90 x 9.5 x 15 cm
Double mattress cushion	90 x 19.5 x 15 cm
Number of mattress units	15 single, 2 double
Max user weight	110kg

Dreama Positioning Pads

- Made from comfortable and hygienic PU. Positioning Pad Combos include angle-adjustable positioning pad, memory foam pad, and towelling cover.
- Use to position the trunk, arms or legs.
- Slimline Support option is an alternative slimmer support than the standard positioning pads.
- Removable memory foam pad (shown in green) for extra comfort and pressure relief. Ideal for support of areas with bony prominences.
- Additional covers available for all positioning pads in white towelling.

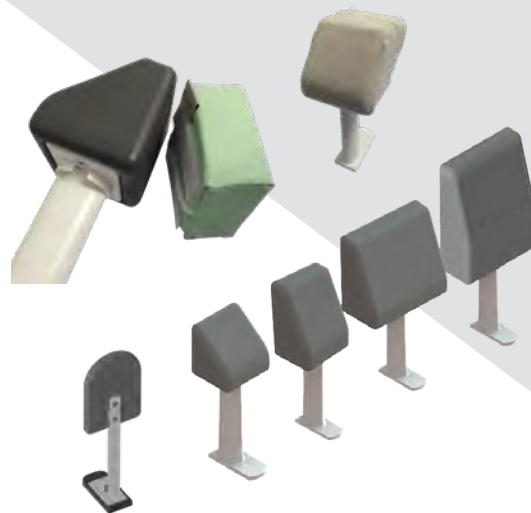

	Pad Combo	Spare Cover	L	W	H
Slimline	7120-3250-500	7120-3280-000	-	108 mm	159 mm
Small	7120-3251-500	7120-3281-000	102 mm	83 mm	95 mm
Medium	7120-3252-500	7120-3282-000	102 mm	83 mm	140 mm
Large	7120-3253-500	7120-3283-000	203 mm	89 mm	165 mm
X large	7120-3254-500	7120-3284-000	203 mm	89 mm	267mm

Dreama Abduction Block

- Can be used individually or in pairs to ensure the hips are abducted and the body is straight.
- Ideal for users with increased abductor tone or where positioning into hip abduction is required.

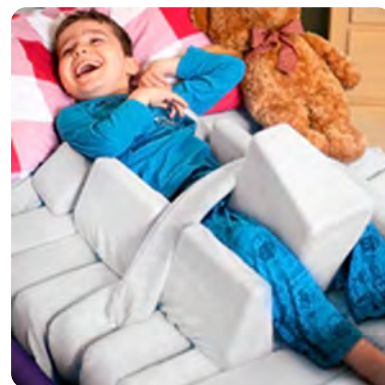

	Size 1	Size 2
Code	7120-1601-000	7120-1602-000
Cover	7120-1661-000	7120-1662-000
Width	130 mm	240 mm
Depth	200 mm	300 mm
Height	260 mm	310 mm

Dreama Knee Blocks

- Comfortably holds the knees in a specified position.

	Small	Large
Code	7120-1751-000	7120-1753-000
Cover	7120-1781-000	7120-1783-000
Width	77 mm	108 mm
Depth	102 mm	102 mm
Height	51 mm	102 mm



Dreama Side Lying System

- Complete system includes a combination of positioning pads, supportive strap and foam support pad. The straps attach to standard Dreama positioning pads.
- Side Lying Support Strap can be used to secure the upper leg when side lying. Includes fittings to fit to two standard positioning pads.
- Side Lying Foam Pad is available in different thicknesses to encourage neutral hip positioning of the top hip in side lying.

	Size 1	Size 2	Size 3
Lying Pad	7120-1851-000	7120-1852-000	7120-1853-000
Pad Cover	7120-1861-000	7120-1862-000	7120-1863-000
Pad Width	345 mm	445 mm	540 mm
Pad Depth	120 mm	140 mm	159 mm
Pad Height	35 mm	51 mm	76 mm
Strap Code	7120-1872-000		
Strap Cover	7120-1882-000		
Strap Dims	140 mm wide x 388 mm long x 57 mm high		



Dreama Positioning Hoop

- Functional item which keeps covers away from the body.
- Allows movement within a limited range for a comfortable night's sleep.

	Small	Medium	Large
Code	7120-1951-000	7120-1952-000	7120-1953-000
Cover	7120-1961-000	7120-1962-000	7120-1963-000
Width	70 mm	70 mm	70 mm
Length	432 mm	560 mm	700 mm
Height	15 mm	15 mm	15 mm

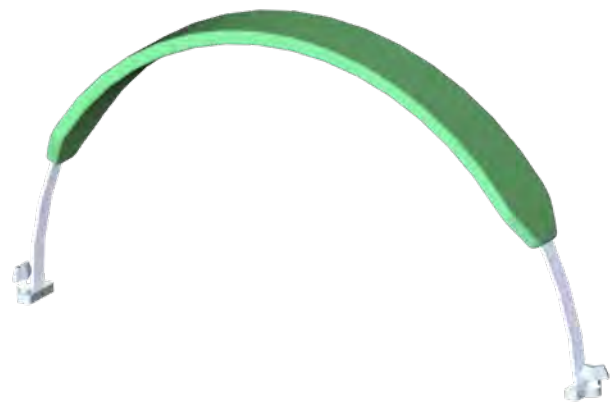

Dreama T-Roll

- Versatile, height adjustable accessory. Supports the knees, reduces abdominal pressure and prevents scissoring and wind-sweeping.
- Each leg support is height adjustable and the Medial Knee Support can be removed.

	One Size
Code	7120-1771-000
Cover	7120-1761-000
Width	527 mm
Length	108 mm
Height	121 mm

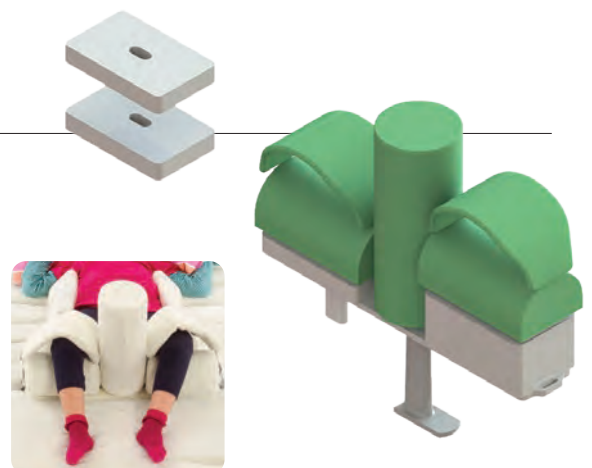

Resources to share knowledge, assist with assessment and help find the best solution to support your clients in lying!



Explore our extensive
online resources available
to download at
[www.medifab.com.au/
knowledge-base](http://www.medifab.com.au/knowledge-base)



Better nights,
better days



Beds



Enjoy a better night's sleep for both of you. When you know they're safe and secure you can both expect better sleep. A Safe Surround Bed is the whole of life solution for any individual with demanding needs. Get the rest you both need with safety you can trust in.

Safe Surround Genie Bed

100

Safe Surround Plus Bed

101

Safe Surround Genie Bed

The Safe Surround Genie bed is for children and adults that can be found in dangerous positions due to movement during the night and need a safe environment for greater containment.

Superior Nursing Care for Children and Adults

Perspex panels provide free eye contact with carers, and the individual can take in what is going on around them

High quality craftsmanship: durable Beech timber with attractive aesthetics



For **carers in wheelchairs** Genie provides ample clearance of up to 74 cm

Sufficient clearance for **hoist transfers**

Standard Features



Adjustable lying surface including 4 section profile sleeping platform, Standard foam mattress, 4 locking castors.



Raise mattress level high to assist carers when tending to the client.



Lower mattress level to enable independent transfers.

SAFETY FEATURES FOR GENIE & PLUS BEDS

- Safe interior to prevent entrapment of head or limbs.
- Special door locking system prevents the doors being opened from the inside.
- Unique door hinge system that doesn't entrap fingers.
- High quality fittings and locking mechanisms.
- Power cut-off plug. When the hand switch is not activated (power disconnected state) all electrical components of the bed are disconnected from the mains and therefore no electricity is used. Electric and magnetic fields in the bed are prevented.
- Maintenance-free DC motors and manual safety switch.
- Emergency lowering in the case of power failure
- Special wooden surface coating that seals the surfaces for maximum hygiene.
- Sweat and saliva resistant wood treatment in accordance with DIN 71-3 Children's Toys Safety Act.

OPTIONS

Mattress Incontinence Cover
7956-0026-000

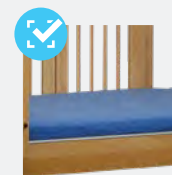

Pressure Relief Foam Mattress
7956-0011-051

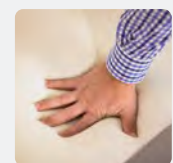

Internal Padding as Required. Velcro attachment.



Code	Door Height	Clearance Height (For Wheelchair)	Weight Limit	Inside Dimensions	Overall Height	Lying Height	Outside Dimensions
7959-0006-000	98 cm	74 cm	150 kg	200 x 90 cm	Min. 137 cm Max. 197 cm	Min. 42cm Max. 102 cm	223 x 101 cm



Safe Surround Plus Bed

The Safe Surround Plus beds are for children and adults that are able to pull themselves to kneeling and/or standing positions and require higher bed doors to provide a safe environment.

Safe environment for active people with challenging behaviour

Designed for those who have **restless motor functions** or **seriously disruptive behaviours**

High quality craftsmanship: durable Beech timber with attractive aesthetics



Extremely stable and strong construction to withstand forces

Lower the mattress level to enable **self-transfers**

Standard Features



Roomy internal measurements and door height options to protect almost any active child from harming themselves.



- Height adjustable lying surface
- 5 section profiling sleeping platform



- Standard foam mattress
- External door locking bar

DOOR SYSTEM

Two handed exterior door release system with special locking system that prevents the doors being opened from the inside.



PROFILING SLEEP PLATFORM

Assists physical needs of the user, and height adjustable to achieve ergonomic height for the parent/carer

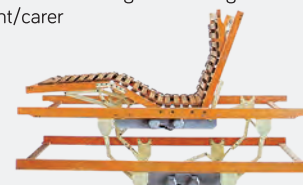

OPTIONS

Mattress Incontinence Cover
7956-0027-000

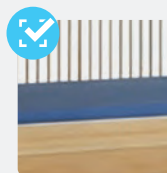

Pressure Relief Foam Mattress
7956-0011-051

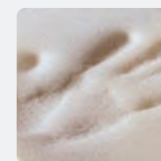

Internal Padding as Required. Velcro attachment.



Code	Door Height	Weight Limit	Inside Dimensions	Overall Height	Lying Height	Outside Dimensions
7953-0008-000	135 cm	150 kg	200 x 100 cm	184 cm	55 cm - 95 cm platform height (top of mattress)	215 x 117cm (with locking bars in place)
7953-0011-000	170 cm			220 cm		

medifab

26 Pardoe Street
East Devonport TAS
7310 Australia

1300 543 343 (AU)

solutions@medifab.com

medifab.com



THIS RESOURCE BELONGS TO: